

JASON[®]

tools n hardware



The Art Of Tools

DIRECTORY
2023

DIRECTORY 2023

INDEX SORT BY ITEM NO.

ITEM NO.		PAGE
343		
343-001	SEKOP PASIR GAGANG FIBER PAPAK	51
343-002	SEKOP PASIR GAGANG FIBER LANCIP	51
343-003	SEKOP SEPADAN GAGANG KAYU	51
344		
344-004	JAS HUJAN HIJAU M	173
344-005	JAS HUJAN & CELANA SCOTLIGHT XL	173
344-022	LAMPU PELAMPUNG AIR	179
345		
345-020	ALAT JEPIT SERBAGUNA 450 MM	156
345-021	ALAT JEPIT SERBAGUNA 600 MM	156
345-190	TONGKAT LAMPU LALU LINTAS	13
345-207	RODA DEPAN (KECIL) HAND PALLET 3"	151
345-210	TALI PENARIK MOBIL	14
345-211	ALAS MEKANIK 40"	14
345-301	RANTAI PLASTIK 6 MM X 25 M (MERAH)	171
345-302	RANTAI PLASTIK 8 MM X 25 M (MERAH)	171
345-303	RANTAI PLASTIK 10 MM X 25 M (MERAH)	171
345-304	RANTAI PLASTIK 12 MM X 25 M (MERAH)	171
345-305	RANTAI PLASTIK 6 MM X 25 M (KUNING)	171
345-306	RANTAI PLASTIK 8 MM X 25 M (KUNING)	171
345-307	RANTAI PLASTIK 10 MM X 25 M (KUNING)	171
345-308	RANTAI PLASTIK 12 MM X 25 M (KUNING)	171
345-309	RANTAI PLASTIK 6 MM X 25 M (HITAM)	171
345-310	RANTAI PLASTIK 8 MM X 25 M (HITAM)	171
345-311	RANTAI PLASTIK 10 MM X 25 M (HITAM)	171
345-312	RANTAI PLASTIK 12 MM X 25 M (HITAM)	171
345-401	KAPUR BESI	36
346		
346-008	KUNCI PAS SATIN CR-V 14 X 15 MM	90
346-010	KUNCI PAS SATIN CR-V 16 X 17 MM	90
346-012	KUNCI PAS SATIN CR-V 18 X 19 MM	90
346-013	KUNCI PAS SATIN CR-V 20 X 22 MM	90
346-014	KUNCI PAS SATIN CR-V 21 X 23 MM	90
346-015	KUNCI PAS SATIN CR-V 24 X 27 MM	90
346-016	KUNCI PAS SATIN CR-V 25 X 28 MM	90
346-017	KUNCI PAS SATIN CR-V 30 X 32 MM	90
346-028	KUNCI RING SATIN CR-V 14 X 15 MM	91
346-030	KUNCI RING SATIN CR-V 16 X 17 MM	91
346-036	KUNCI RING SATIN CR-V 25 X 28 MM	91
346-037	KUNCI RING SATIN CR-V 30 X 32 MM	91
346-041	KUNCI RING PAS SATIN CR-V 8 MM	92
346-042	KUNCI RING PAS SATIN CR-V 9 MM	92
346-044	KUNCI RING PAS SATIN CR-V 11 MM	92

ITEM NO.		PAGE
346-049	KUNCI RING PAS SATIN CR-V 16 MM	92
346-053	KUNCI RING PAS SATIN CR-V 20 MM	92
346-054	KUNCI RING PAS SATIN CR-V 21 MM	92
346-055	KUNCI RING PAS SATIN CR-V 22 MM	92
346-072	KUNCI PAS SATIN CR-V SET 8 PCS (6 - 22 MM)	90
346-073	KUNCI PAS SATIN CR-V SET 12 PCS (6 - 32 MM)	90
346-076	KUNCI RING BULAN SATIN CR-V 10 X 12 MM	98
346-077	KUNCI RING BULAN SATIN CR-V 11 X 13 MM	98
346-078	KUNCI RING BULAN SATIN CR-V 14 X 17 MM	98
346-079	KUNCI RING BULAN SATIN CR-V 16 X 18 MM	98
346-091	KUNCI RING BINTANG SATIN CR-V 4 PCS	98
346-100	KUNCI SOK MODEL L 17 MM	106
346-101	KUNCI SOK MODEL L 19 MM	106
346-103	KUNCI SOK MODEL L 23 MM	106
346-106	KUNCI SOK T 3 IN 1 8 X 9 X 10 MM	107
346-107	KUNCI SOK T 3 IN 1 8 X 10 X 12 MM	107
346-108	KUNCI SOK T 3 IN 1 10 X 11 X 13 MM	107
346-109	KUNCI SOK T 3 IN 1 10 X 12 X 14 MM	107
346-110	KUNCI SOK T 3 IN 1 12 X 14 X 17 MM	107
346-113	KUNCI SOK T CR-V HANDLE KARET HITAM 11 MM	107
346-115	KUNCI SOK T CR-V HANDLE KARET HITAM 13 MM	107
346-124	KUNCI SOK T SLIDING 12 MM	107
346-126	KUNCI SOK T SLIDING 14 MM	107
346-127	KUNCI SOK T SLIDING 17 MM	107
346-131	KUNCI SOK T CR-V HITAM 8 MM	107
346-132	KUNCI SOK T CR-V HITAM 10 MM	107
346-133	KUNCI SOK T CR-V HITAM 11 MM	107
346-134	KUNCI SOK T CR-V HITAM 12 MM	107
346-135	KUNCI SOK T CR-V HITAM 13 MM	107
346-136	KUNCI SOK T CR-V HITAM 14 MM	107
346-137	KUNCI SOK T CR-V HITAM 17 MM	107
346-140	KUNCI SOK ROTARI 8 IN 1	99
346-141	KUNCI SOK Y KHROM 8 X 9 X 10 MM	109
346-142	KUNCI SOK Y KHROM 8 X 10 X 12 MM	109
346-143	KUNCI SOK Y KHROM 10 X 11 X 13 MM	109
346-144	KUNCI SOK Y KHROM 10 X 12 X 14 MM	109
346-145	KUNCI SOK Y KHROM 12 X 14 X 17 MM	109
346-146	KUNCI SOK T ROTARI 8 MM	108
346-147	KUNCI SOK T ROTARI 10 MM	108
346-149	KUNCI SOK T ROTARI 14 MM	108
346-150	KUNCI SOK T ROTARI 17 MM	108
346-151	KUNCI SOK Y HITAM LONG 8 X 9 X 10 MM	109
346-152	KUNCI SOK Y HITAM LONG 8 X 10 X 12 MM	109
346-153	KUNCI SOK Y HITAM LONG 10 X 11 X 13 MM	109
346-154	KUNCI SOK Y HITAM LONG 10 X 12 X 14 MM	109
346-155	KUNCI SOK Y HITAM LONG 12 X 14 X 17 MM	109
346-157	KUNCI L CR-V BINTANG T45	88
346-158	KUNCI L CR-V BINTANG T50	88
346-160	KUNCI BACO KHROM 18"	84
346-162	KUNCI BACO SATIN 8"	84
346-163	KUNCI BACO SATIN 10"	84
346-164	KUNCI BACO SATIN 12"	84
346-165	KUNCI BACO SATIN 15"	84
346-171	KUNCI L CR-V 10 PCS 1.5-10 MM	86
346-172	KUNCI L CR-V 10 PCS 1/16-3/8"	86
346-173	KUNCI L BALLPOINT 9 PCS 1.5-10 MM	86
346-175	KUNCI L LIPAT BINTANG 8 PCS T9-T40	86
346-176	KUNCI L BALLPOINT EXTRA LONG 9 PCS 1.5-10MM	86
346-178	KUNCI L CR-V 5 PCS X 6 MM	88
346-182	KUNCI L HITAM 10 PCS	87
346-187	KUNCI L BINTANG LONG 9 PCS T10-T50	87
346-191	KUNCI OLI FILTER 3 KAKI	12
346-192	KUNCI OLI FILTER KULIT 9"	12

ITEM NO.	PAGE	ITEM NO.	PAGE		
346-195	KUNCI OLI FILTER RANTAI 9"	12	346-460	KUNCI SOK 6 POINT 16 MM	102
346-196	KUNCI BUSI FLEKSIBEL 16 MM	104	346-461	KUNCI SOK 6 POINT 17 MM	102
346-197	KUNCI BUSI FLEKSIBEL 21 MM	104	346-462	KUNCI SOK 6 POINT 18 MM	102
346-198	KUNCI SOK BUSI CR-V 1/2 X 16" MM	104	346-463	KUNCI SOK 6 POINT 19 MM	102
346-199	KUNCI SOK BUSI CR-V 1/2 X 21" MM	104	346-464	KUNCI SOK 6 POINT 20 MM	102
346-201	KUNCI RODA L 1/2" X 19 & 21 MM	106	346-465	KUNCI SOK 6 POINT 21 MM	102
346-206	KUNCI BACO KHROM 10"	84	346-466	KUNCI SOK 6 POINT 22 MM	102
346-207	KUNCI BACO KHROM 12"	84	346-467	KUNCI SOK 6 POINT 23 MM	102
346-208	KUNCI BACO KHROM 15"	84	346-468	KUNCI SOK 6 POINT 24 MM	102
346-211	KUNCI RODA PALANG UNGU METALIK 15"	105	346-469	KUNCI SOK 6 POINT 27 MM	102
346-212	KUNCI RODA PALANG BIRU METALIK 14"	105	346-470	KUNCI SOK 6 POINT 30 MM	102
346-213	KUNCI RODA PALANG KHROM GAGANG KARET 14"	105	346-471	KUNCI SOK 6 POINT 32 MM	102
346-214	KUNCI RODA TRUCK REDUCER	106	346-480	KUNCI DOUBLE RATCHET CR-V HITAM 10 X 12 MM	85
346-229	KUNCI SEPEDA KABEL	169	346-481	KUNCI DOUBLE RATCHET CR-V HITAM 11 X 13 MM	85
346-231	KUNCI L GAGANG T CR-V T 2,5	89	346-482	KUNCI DOUBLE RATCHET CR-V HITAM 12 X 14 MM	85
346-232	KUNCI L GAGANG T CR-V T 3	89	346-483	KUNCI DOUBLE RATCHET CR-V HITAM 14 X 17 MM	85
346-235	KUNCI L GAGANG T CR-V T 6	89	346-513	KUNCI PAS CR-V HITAM 20 X 22 MM	93
346-236	KUNCI L GAGANG T CR-V T 8	89	346-515	KUNCI PAS CR-V HITAM 24 X 27 MM	93
346-237	KUNCI L GAGANG T CR-V T 10	89	346-516	KUNCI PAS CR-V HITAM 25 X 28 MM	93
346-251	KUNCI PIPA 10"	85	346-517	KUNCI PAS CR-V HITAM 30 X 32 MM	93
346-252	KUNCI PIPA 12"	85	346-533	KUNCI RING CR-V HITAM 20 X 22 MM	93
346-253	KUNCI PIPA 14"	85	346-534	KUNCI RING CR-V HITAM 21 X 23 MM	93
346-254	KUNCI PIPA 18"	85	346-535	KUNCI RING CR-V HITAM 24 X 27 MM	93
346-255	KUNCI PIPA 24"	85	346-536	KUNCI RING CR-V HITAM 25 X 28 MM	93
346-256	KUNCI PIPA 36"	85	346-537	KUNCI RING CR-V HITAM 30 X 32 MM	93
346-274	KUNCI BACO SATIN GG KUNING HITAM 8"	84	346-549	KUNCI RING PAS CR-V HITAM 16 MM	93
346-282	KUNCI SOK T GAGANG KARET 11 MM	108	346-553	KUNCI RING PAS CR-V HITAM 20 MM	93
346-283	KUNCI SOK T GAGANG KARET 12 MM	108	346-554	KUNCI RING PAS CR-V HITAM 21 MM	93
346-284	KUNCI SOK T GAGANG KARET 13 MM	108	346-555	KUNCI RING PAS CR-V HITAM 22 MM	93
346-285	KUNCI SOK T GAGANG KARET 14 MM	108	346-564	KUNCI RING PAS CR-V HITAM 28 MM	93
346-287	KUNCI SOK T GAGANG KARET 19 MM	108	346-586	KUNCI KLEP SEPEDA MOTOR MODEL L	18
346-302	STANG SOK L SATIN CR-V 1/2" X 250 MM	103	346-600	KUNCI RING PAS SATIN CR-V 33 MM	92
346-303	SLIDING T SATIN CR-V 1/2" X 250 MM	103	346-601	KUNCI RING PAS SATIN CR-V 34 MM	92
346-304	EXTENSION BAR SATIN CR-V 1/2" X 75 MM	103	346-602	KUNCI RING PAS SATIN CR-V 35 MM	92
346-305	EXTENSION BAR SATIN CR-V 1/2" X 125 MM	103	346-605	KUNCI RING PAS SATIN CR-V 41 MM	92
346-306	EXTENSION BAR SATIN CR-V 1/2" X 250 MM	103	346-606	KUNCI RING PAS SATIN CR-V 46 MM	92
346-308	STANG SOK RATCHET SATIN CR-V 1/2" X 260 MM	103	346-607	KUNCI RING PAS SATIN CR-V 50 MM	92
346-309	SLIDING T HITAM CR-MO 3/4"	99	346-621	KUNCI RING PAS SATIN CR-V 5/16"	92
346-321	KUNCI L KOMBINASI SATIN 9 PCS	87	346-622	KUNCI RING PAS SATIN CR-V 3/8"	92
346-330	KUNCI L SATIN KHROM CR-V 1,5 MM	89	346-623	KUNCI RING PAS SATIN CR-V 7/16"	92
346-331	KUNCI L SATIN KHROM CR-V 2 MM	89	346-624	KUNCI RING PAS SATIN CR-V 1/2"	92
346-332	KUNCI L SATIN KHROM CR-V 2,5 MM	89	346-625	KUNCI RING PAS SATIN CR-V 9/16"	92
346-333	KUNCI L SATIN KHROM CR-V 3 MM	89	346-626	KUNCI RING PAS SATIN CR-V 5/8"	92
346-334	KUNCI L SATIN KHROM CR-V 4 MM	89	346-627	KUNCI RING PAS SATIN CR-V 11/16"	92
346-335	KUNCI L SATIN KHROM CR-V 5 MM	89	346-628	KUNCI RING PAS SATIN CR-V 3/4"	92
346-336	KUNCI L SATIN KHROM CR-V 6 MM	89	346-629	KUNCI RING PAS SATIN CR-V 13/16"	92
346-337	KUNCI L SATIN KHROM CR-V 8 MM	89	346-630	KUNCI RING PAS SATIN CR-V 7/8"	92
346-338	KUNCI L SATIN KHROM CR-V 10 MM	89	346-631	KUNCI RING PAS SATIN CR-V 15/16"	92
346-339	KUNCI L SATIN KHROM CR-V 12 MM	89	346-632	KUNCI RING PAS SATIN CR-V 1"	92
346-340	KUNCI L SATIN KHROM CR-V 14 MM	89	346-633	KUNCI RING PAS SATIN CR-V 1 1/6"	92
346-401	KUNCI SOK SET 9 PCS	101	346-634	KUNCI RING PAS SATIN CR-V 1 1/8"	92
346-402	KUNCI SOK SET 10 PCS	101	346-635	KUNCI RING PAS SATIN CR-V 1 1/4"	92
346-403	KUNCI SOK SET 25 PCS	101	346-643	KUNCI RING PAS RATCHET SATIN 10 MM	98
346-404	KUNCI SOK 8 PCS 3/8" (8 - 19 MM)	104	346-644	KUNCI RING PAS RATCHET SATIN 11 MM	98
346-405	KUNCI SOK 8 PCS 1/2" (10 - 19 MM)	104	346-660	KUNCI SOK 12 POINT 8 MM	102
346-452	KUNCI SOK 6 POINT 8 MM	102	346-661	KUNCI SOK 12 POINT 9 MM	102
346-453	KUNCI SOK 6 POINT 9 MM	102	346-662	KUNCI SOK 12 POINT 10 MM	102
346-454	KUNCI SOK 6 POINT 10 MM	102	346-663	KUNCI SOK 12 POINT 11 MM	102
346-455	KUNCI SOK 6 POINT 11 MM	102	346-664	KUNCI SOK 12 POINT 12 MM	102
346-456	KUNCI SOK 6 POINT 12 MM	102	346-665	KUNCI SOK 12 POINT 13 MM	102
346-457	KUNCI SOK 6 POINT 13 MM	102	346-666	KUNCI SOK 12 POINT 14 MM	102
346-458	KUNCI SOK 6 POINT 14 MM	102	346-667	KUNCI SOK 12 POINT 15 MM	102
346-459	KUNCI SOK 6 POINT 15 MM	102	346-668	KUNCI SOK 12 POINT 16 MM	102

ITEM NO.	PAGE	ITEM NO.	PAGE
346-669	102	KUNCI RING KHROM 12 X 13 MM	95
346-670	102	346-777 KUNCI RING KHROM 12 X 14 MM	95
346-671	102	346-778 KUNCI RING KHROM 14 X 15 MM	95
346-672	102	346-779 KUNCI RING KHROM 14 X 17 MM	95
346-673	102	346-780 KUNCI RING KHROM 16 X 17 MM	95
346-674	102	346-781 KUNCI RING KHROM 17 X 19 MM	95
346-675	102	346-782 KUNCI RING KHROM 18 X 19 MM	95
346-676	102	346-783 KUNCI RING KHROM 20 X 22 MM	95
346-677	102	346-784 KUNCI RING KHROM 21 X 23 MM	95
346-678	102	346-785 KUNCI RING KHROM 24 X 27 MM	95
346-679	102	346-786 KUNCI RING KHROM 25 X 28 MM	95
346-713	91	346-787 KUNCI RING KHROM 30 X 32 MM	95
346-722	94	346-789 KUNCI RING KHROM SET 8 PCS (6-24 MM)	95
346-723	94	346-790 KUNCI RING KHROM SET 12 PCS (6-32 MM)	95
346-724	94	346-791 KUNCI RING PAS KHROM 41 MM	96
346-725	94	346-792 KUNCI RING PAS KHROM 42 MM	96
346-726	94	346-793 KUNCI RING PAS KHROM 46 MM	96
346-727	94	346-794 KUNCI RING PAS KHROM 50 MM	96
346-728	94	346-801 KUNCI SOK IMPACT HITAM 22 MM X 3/4" DR	100
346-729	94	346-802 KUNCI SOK IMPACT HITAM 23 MM X 3/4" DR	100
346-730	94	346-805 KUNCI SOK IMPACT HITAM 28 MM X 3/4" DR	100
346-731	94	346-808 KUNCI SOK IMPACT HITAM 33 MM X 3/4" DR	100
346-732	94	346-809 KUNCI SOK IMPACT HITAM 34 MM X 3/4" DR	100
346-733	94	346-810 KUNCI SOK IMPACT HITAM 35 MM X 3/4" DR	100
346-734	94	346-812 KUNCI SOK IMPACT HITAM 38 MM X 3/4" DR	100
346-735	94	346-813 KUNCI SOK IMPACT HITAM 41 MM X 3/4" DR	100
346-736	94	346-814 KUNCI SOK IMPACT HITAM 42 MM X 3/4" DR	100
346-737	94	346-815 KUNCI SOK IMPACT HITAM 45 MM X 3/4" DR	100
346-738	94	346-817 KUNCI SOK IMPACT HITAM 48 MM X 3/4" DR	100
346-739	94	346-818 KUNCI SOK IMPACT HITAM 50 MM X 3/4" DR	100
346-740	99	346-821 KUNCI SOK IMPACT HITAM 22 MM X 1" DR	100
346-742	96	346-822 KUNCI SOK IMPACT HITAM 23 MM X 1" DR	100
346-743	96	346-823 KUNCI SOK IMPACT HITAM 24 MM X 1" DR	100
346-744	96	346-825 KUNCI SOK IMPACT HITAM 28 MM X 1" DR	100
346-745	96	346-826 KUNCI SOK IMPACT HITAM 30 MM X 1" DR	100
346-746	96	346-829 KUNCI SOK IMPACT HITAM 34 MM X 1" DR	100
346-747	96	346-830 KUNCI SOK IMPACT HITAM 35 MM X 1" DR	100
346-748	96	346-831 KUNCI SOK IMPACT HITAM 36 MM X 1" DR	100
346-749	96	346-832 KUNCI SOK IMPACT HITAM 38 MM X 1" DR	100
346-750	96	346-834 KUNCI SOK IMPACT HITAM 42 MM X 1" DR	100
346-751	96	346-835 KUNCI SOK IMPACT HITAM 45 MM X 1" DR	100
346-752	96	346-836 KUNCI SOK IMPACT HITAM 46 MM X 1" DR	100
346-753	96	346-837 KUNCI SOK IMPACT HITAM 48 MM X 1" DR	100
346-754	96	346-838 KUNCI SOK IMPACT HITAM 50 MM X 1" DR	100
346-755	96	346-841 KUNCI SOK IMPACT ADAPTOR CR-MO 1/2" F X 3/4"	100
346-756	96	346-842 KUNCI SOK IMPACT ADAPTOR CR-MO 3/4" F X 1/2"	100
346-758	96	346-843 KUNCI SOK IMPACT ADAPTOR CR-MO 3/4" F X 1"	100
346-759	96	347	
346-760	96	347-000 TANG KOMBINASI MINI 4.5"	125
346-761	96	347-001 TANG KOMBINASI SATIN 6"	122
346-762	96	347-002 TANG KOMBINASI SATIN 7"	122
346-763	96	347-003 TANG KOMBINASI SATIN 8"	122
346-764	96	347-004 TANG KOMBINASI HEAVY DUTY 8"	123
346-765	96	347-006 TANG POTONG MINI 4.5"	125
346-766	96	347-007 TANG KOMBINASI KHROM 6"	124
346-767	97	347-008 TANG KOMBINASI KHROM 7"	124
346-768	97	347-009 TANG KOMBINASI KHROM 8"	124
346-769	97	347-011 TANG LANCIP SATIN 6"	122
346-771	95	347-012 TANG LANCIP KHROM 6"	124
346-772	95	347-016 TANG LANCIP MINI 4.5"	125
346-773	95	347-021 TANG POTONG SATIN 6"	122
346-774	95	347-022 TANG POTONG KHROM 6"	124
346-775	95	347-023 TANG POTONG ELEKTRIK 125 MM"	123

ITEM NO.	PAGE	ITEM NO.	PAGE		
347-024	TANG POTONG ELEKTRIK 160 MM"	123	348-047	OBENG ELEKTRONIK CR-V 6" X 3 MM (+)	112
347-026	TANG KAKAKTUA MINI 4,5"	126	348-048	OBENG ELEKTRONIK CR-V 6" X 3 MM (-)	112
347-031	TANG BUAYA MODEL OVAL 10"	127	348-049	OBENG ELEKTRONIK CR-V 8" X 3 MM (+)	112
347-032	TANG BUAYA MODEL FLAT 10"	127	348-050	OBENG ELEKTRONIK CR-V 8" X 3 MM (-)	112
347-033	TANG BUAYA MODEL BULAT 10"	127	348-081	OBENG CEBOL CR-V 1,5" x 6 MM (+)	111
347-040	TANG BUAYA MODEL BULAT HITAM 10"	127	348-082	OBENG CEBOL CR-V 1,5" x 6 MM (-)	111
347-041	TANG RIVET BODI HITAM 9,5"	129	348-083	OBENG CEBOL 2 PCS	111
347-042	TANG RIVET BODI KHROM 10"	129	348-101	OBENG LISTRIK 5 PCS	114
347-043	TANG RIVET TIPE JAPAN 10,5"	129	348-106	OBENG HANDPHONE 4 PCS	116
347-044	TANG RIVET FLEKSIBEL TIPE EROPA 11,5"	129	348-109	OBENG T ROTARI PH 2	113
347-046	TANG SLIP JOINT 6"	124	348-111	OBENG TESPEN 7"	114
347-047	TANG SLIP JOINT 8"	124	348-115	OBENG TESPEN TEGANGAN DC	114
347-051	TANG SNAP RING BENGKOK BUKA 7"	128	348-116	OBENG FARADIC TESTER 5,5"	114
347-052	TANG SNAP RING LURUS BUKA 7"	128	348-121	OBENG ARLOJI 6 PCS	115
347-053	TANG SNAP RING BENGKOK TUTUP 7"	128	348-122	OBENG ARLOJI CR-V 6 PCS	115
347-054	TANG SNAP RING LURUS TUTUP 7"	128	348-130	OBENG TEMBUS CR-V GAGANG BIRU 3" X 5MM (+)	110
347-065	TANG TERMINAL KOMPUTER	131	348-131	OBENG TEMBUS CR-V GAGANG BIRU 3" X 5MM (-)	110
347-066	TANG KUPAS KABEL SATIN 6"	122	348-132	OBENG TEMBUS CR-V GAGANG BIRU 4" X 6MM (+)	110
347-067	TANG KUPAS KABEL OTOMATIS 7"	131	348-133	OBENG TEMBUS CR-V GAGANG BIRU 4" X 6MM (-)	110
347-068	TANG KUPAS KABEL OTO BODI BESI	131	348-134	OBENG TEMBUS CR-V GAGANG BIRU 5" X 6MM (+)	110
347-069	TANG SKUN KABEL SERBAGUNA 8"	132	348-135	OBENG TEMBUS CR-V GAGANG BIRU 5" X 6MM (-)	110
347-070	TANG SERBAGUNA 18 IN 1	161	348-136	OBENG TEMBUS CR-V GAGANG BIRU 6" X 6MM (+)	110
347-071	TANG LANCIP BENGKOK MINI 4,5"	126	348-137	OBENG TEMBUS CR-V GAGANG BIRU 6" X 6MM (-)	110
347-077	TANG KAKAKTUA 7"	130	348-138	OBENG TEMBUS CR-V GAGANG BIRU 8" X 6MM (+)	110
347-078	TANG KAKAKTUA 8"	130	348-139	OBENG TEMBUS CR-V GAGANG BIRU 8" X 6MM (-)	110
347-094	TANG KAKAKTUA BODI PANJANG 9"	130	348-141	OBENG GAGANG KARET CR-V 4" X 6 MM (+)	112
347-095	TANG KAKAKTUA BODI PANJANG 10"	130	348-142	OBENG GAGANG KARET CR-V 4" X 6 MM (-)	112
347-099	TANG 4 PCS 6"	123	348-143	OBENG GAGANG KARET CR-V 5" X 6 MM (+)	112
347-100	TANG MINI SATIN SET 5 PCS	126	348-144	OBENG GAGANG KARET CR-V 5" X 6 MM (-)	112
347-112	TANG TERMINAL SKUN KABEL 7,5"	132	348-145	OBENG GAGANG KARET CR-V 6" X 6 MM (+)	112
347-114	ALAT PEMBENGKOK PIPA TEMBAGA 3 IN 1	80	348-146	OBENG GAGANG KARET CR-V 6" X 6 MM (-)	112
347-201	TANG PLONG KULIT ROTARI 8"	133	348-151	MATA OBENG KETOK 6 PCS PH 2 X 80 MM	117
347-300	TANG POTONG PIPA PVC 42 MM	130	348-152	MATA OBENG KETOK 6 PCS PH 3 X 80 MM	117
347-401	TANG SIWARAN GERGAJI 175 MM	130	348-156	MT OBENG KETOK S2 BROWN 10 PCS PH 2X80MM	117
347-501	ALAT CABUT PAKU 12 MM X 300 MM	23	348-157	MT OBENG KETOK S2 BROWN 10 PCS PH 3X80MM	117
347-502	ALAT CABUT PAKU 16 MM X 450 MM	23	348-161	OBENG KETOK 5 PCS	117
347-503	ALAT CABUT PAKU 16 MM X 600 MM	23	348-163	OBENG KETOK 12 PCS	117
348			348-173	MAGNETIC SOCKET 4 PCS	23
348-001	OBENG TEMBUS GG TRANSPARAN 3" X 5 MM (-)	110	348-181	MATA OBENG ANGIN 10 PCS 65 MM X PH 2	118
348-002	OBENG TEMBUS GG TRANSPARAN 3" X 5 MM (+)	110	348-182	MATA OBENG ANGIN 10 PCS 65 MM X SLOT 6	118
348-003	OBENG TEMBUS GG TRANSPARAN 4" X 6 MM (-)	110	348-191	OBENG RATCHET MODEL T BOLAK BALIK	113
348-004	OBENG TEMBUS GG TRANSPARAN 4" X 6 MM (+)	110	348-192	OBENG RATCHET BOLAK BALIK	113
348-005	OBENG TEMBUS GG TRANSPARAN 5" X 6 MM (-)	110	348-213	OBENG S2.15 IN 1	116
348-006	OBENG TEMBUS GG TRANSPARAN 5" X 6 MM (+)	110	348-215	OBENG CR-V 10 IN 1	116
348-007	OBENG TEMBUS GG TRANSPARAN 6" X 6 MM (-)	110	348-541	OBENG ELEKTRONIK CR-V 3" X 3 MM (+)	112
348-008	OBENG TEMBUS GG TRANSPARAN 6" X 6 MM (+)	110	348-542	OBENG ELEKTRONIK CR-V 3" X 3 MM (-)	112
348-009	OBENG TEMBUS GG TRANSPARAN 8" X 8 MM (-)	110	348-543	OBENG ELEKTRONIK CR-V 4" X 3 MM (+)	112
348-010	OBENG TEMBUS GG TRANSPARAN 8" X 8 MM (+)	110	348-544	OBENG ELEKTRONIK CR-V 4" X 3 MM (-)	112
348-011	OBENG TEMBUS GG TRANSPARAN 10" X 8 MM (-)	110	349		
348-012	OBENG TEMBUS GG TRANSPARAN 10" X 8 MM (+)	110	349-001	BETEL BESI MODEL PAYUNG 8"	31
348-015	OBENG TEMBUS 7 PCS	110	349-002	BETEL BESI MODEL PAYUNG 10"	31
348-021	OBENG COLORLINE CR-V 3" X 6 MM (+)	112	349-003	BETEL BESI MODEL PAYUNG 12"	31
348-022	OBENG COLORLINE CR-V 3" X 6 MM (-)	112	350		
348-023	OBENG COLORLINE CR-V 4" X 6 MM (+)	112	350-023	DRIP CENTER KHROM	31
348-024	OBENG COLORLINE CR-V 4" X 6 MM (-)	112	350-024	MATA BOR UNCEK 4 PCS	59
348-025	OBENG COLORLINE CR-V 5" X 6 MM (+)	112	351		
348-026	OBENG COLORLINE CR-V 5" X 6 MM (-)	112	351-001	PAKU BETON GALVANIS 3 X 1"	48
348-027	OBENG COLORLINE CR-V 6" X 6 MM (+)	112	351-002	PAKU BETON GALVANIS 3 X 1 1/4"	48
348-028	OBENG COLORLINE CR-V 6" X 6 MM (-)	112	351-003	PAKU BETON GALVANIS 3 X 1 1/2"	48
348-029	OBENG COLORLINE CR-V 8" X 6 MM (+)	112	351-004	PAKU BETON GALVANIS 3,6 X 2"	48
348-030	OBENG COLORLINE CR-V 8" X 6 MM (-)	112	351-005	PAKU BETON GALVANIS 4 X 2 1/2"	48
348-045	OBENG ELEKTRONIK CR-V 5" X 3 MM (+)	112	351-006	PAKU BETON GALVANIS 4,2 X 3"	48
348-046	OBENG ELEKTRONIK CR-V 5" X 3 MM (-)	112	351-007	PAKU BETON GALVANIS 4,5 X 4"	48

ITEM NO.	PAGE	ITEM NO.	PAGE		
351-010	PAKU BETON HITAM 25 X 2 MM	48	353-032	MATA BOR BETON PANJANG 10 MM X 300 MM	64
351-011	PAKU BETON HITAM 40 X 3 MM	48	353-033	MATA BOR BETON PANJANG 12 MM X 300 MM	64
351-012	PAKU BETON HITAM 50 X 3 MM	48	353-034	MATA BOR BETON PANJANG 14 MM X 300 MM	64
351-013	PAKU BETON HITAM 60 X 3 MM	48	353-035	MATA BOR BETON PANJANG 16 MM X 300 MM	64
351-014	PAKU BETON HITAM 75 x 4,2 MM	48	353-043	MATA BOR KAYU TINCOATED 5/8"	57
351-015	PAKU BETON HITAM 100 x 4,2 MM	48	353-044	MATA BOR KAYU TINCOATED 3/4"	57
351-105	AKSESORIS SEKRUP KAYU	155	353-045	MATA BOR KAYU TINCOATED 7/8"	57
351-109	AKSESORIS KLEM KABEL PVC	155	353-051	MATA BOR KONES JIS 14 MM	67
351-126	SEKRUP KAYU KUNINGAN 1 1/2" X 8 MM	155	353-053	MATA BOR KONES JIS 15 MM	67
351-214	ENGSEL VER SS 3"	31	353-054	MATA BOR KONES JIS 15.5 MM	67
351-215	ENGSEL VER SS 4"	31	353-055	MATA BOR KONES JIS 16 MM	67
351-216	ENGSEL VER SS 5"	31	353-056	MATA BOR KONES JIS 16.5 MM	67
351-217	ENGSEL VER SS 6"	31	353-058	MATA BOR KONES JIS 17.5 MM	67
351-218	ENGSEL NYLON BEARING SS 3" X 2,5" X 2,0 MM	31	353-060	MATA BOR KONES JIS 18.5 MM	67
351-219	ENGSEL NYLON BEARING SS 4" X 3,0" X 2,3 MM	31	353-061	MATA BOR KONES JIS 19 MM	67
351-220	ENGSEL NYLON BEARING SS 5" X 3,0" X 2,3 MM	31	353-062	MATA BOR KONES JIS 19.5 MM	67
351-221	RODA PAGAR SIKU 6 CM	151	353-063	MATA BOR KONES JIS 20 MM	67
351-222	RODA PAGAR SIKU 7 CM	151	353-064	MATA BOR KONES JIS 20.5 MM	67
351-223	RODA PAGAR SIKU 8 CM	151	353-065	MATA BOR KONES JIS 21 MM	67
351-224	RODA PAGAR BULAT 6 CM	151	353-066	MATA BOR KONES JIS 21.5 MM	67
351-225	RODA PAGAR BULAT 7 CM	151	353-068	MATA BOR KONES JIS 22.5 MM	67
351-226	RODA PAGAR BULAT 8 CM	151	353-069	MATA BOR KONES JIS 23 MM	67
351-227	RODA PAGAR SIKU 10 CM	151	353-070	MATA BOR KONES JIS 23.5 MM	67
351-228	RODA PAGAR BULAT 10 CM	151	353-071	MATA BOR KONES JIS 24 MM	67
352			353-072	MATA BOR KONES JIS 24.5 MM	67
352-001	KIKIR EMAS SET 10 PCS	81	353-073	MATA BOR KONES JIS 25 MM	67
352-002	KIKIR SET 7 PCS	81	353-074	MATA BOR KONES JIS 25.5 MM	67
352-003	KIKIR CHAINSAW 8" X 5,5 MM	81	353-075	MATA BOR KONES JIS 26 MM	67
352-004	KIKIR CHAINSAW 8" X 4,8 MM	81	353-076	MATA BOR KONES JIS 26.5 MM	67
352-006	KIKIR PLAT KASAR 8"	82	353-077	MATA BOR KONES JIS 27 MM	67
352-007	KIKIR PLAT KASAR 10"	82	353-078	MATA BOR KONES JIS 27.5 MM	67
352-008	KIKIR PLAT KASAR 12"	82	353-079	MATA BOR KONES JIS 28 MM	67
352-012	KIKIR SEGITIGA 3"	82	353-080	MATA BOR KONES JIS 28.5 MM	67
352-013	KIKIR SEGITIGA 4"	82	353-081	MATA BOR KONES JIS 29 MM	67
352-014	KIKIR SEGITIGA 5"	82	353-082	MATA BOR KONES JIS 29.5 MM	67
352-015	KIKIR SEGITIGA 6"	82	353-083	MATA BOR KONES JIS 30 MM	67
352-026	KIKIR SETENGAH BULAT KASAR 8"	82	353-090	MATA BOR BETON SET 5 PCS	64
352-027	KIKIR SETENGAH BULAT KASAR 10"	82	353-091	MATA BOR ROTARI TCT 10 PCS SHANK 3 MM	70
352-036	KIKIR BULAT KASAR 8"	82	353-092	MATA BOR ROTARI TCT 10 PCS SHANK 6 MM	70
352-037	KIKIR BULAT KASAR 10"	82	353-094	MATA BOR BETON SDS SET 5 PCS	64
352-038	KIKIR DIAMOND 6 PCS	83	353-200	KUNCI DISGRINDER	133
352-039	KIKIR DIAMOND 5 PCS	83	353-250	MATA BOR KACA 5 PCS	65
352-046	KIKIR KAYU SETENGAH BULAT 8"	83	353-251	MATA BOR KACA LAPIS INTAN 8 MM X 6 MM	65
352-047	KIKIR KAYU SETENGAH BULAT 10"	83	353-252	MATA BOR KACA LAPIS INTAN 8 MM X 8 MM	65
352-048	KIKIR KAYU SETENGAH BULAT 12"	83	353-253	MATA BOR KACA LAPIS INTAN 8 MM X 10 MM	65
353			353-254	MATA BOR KACA LAPIS INTAN 8 MM X 12 MM	65
353-005	MATA BOR KAYU TINCOATED 6 PCS	58	353-255	MATA BOR KACA LAPIS INTAN 8 MM X 15 MM	65
353-006	MATA BOR MULTIFUNGSI 4-12 MM	66	353-256	MATA BOR KACA LAPIS INTAN 8 MM X 20 MM	65
353-007	MATA BOR MULTIFUNGSI 4-20 MM	66	353-257	MATA BOR KACA LAPIS INTAN 8 MM X 22 MM	65
353-008	MATA BOR MULTIFUNGSI 4-32 MM	66	353-258	MATA BOR KACA LAPIS INTAN 8 MM X 25 MM	65
353-011	MATA BOR BETON 4 MM	64	353-259	MATA BOR KACA LAPIS INTAN 8 MM X 30 MM	65
353-012	MATA BOR BETON 5 MM	64	353-260	MATA BOR KACA LAPIS INTAN 8 MM X 32 MM	65
353-013	MATA BOR BETON 6 MM	64	353-261	MATA BOR KACA LAPIS INTAN 8 MM X 35 MM	65
353-014	MATA BOR BETON 8 MM	64	353-262	MATA BOR KACA LAPIS INTAN 8 MM X 40 MM	65
353-015	MATA BOR BETON 10 MM	64	353-263	MATA BOR KACA LAPIS INTAN 8 MM X 42 MM	65
353-017	MATA BOR BETON 12 MM	64	353-264	MATA BOR KACA LAPIS INTAN 8 MM X 45 MM	65
353-019	MATA BOR BETON 14 MM	64	353-265	MATA BOR KACA LAPIS INTAN 8 MM X 50 MM	65
353-020	MATA BOR BETON 16 MM	64	353-266	MATA BOR KACA LAPIS INTAN 8 MM X 55 MM	65
353-021	MATA BOR SET HSS 13 PCS (1,5-6,5MM)	69	353-267	MATA BOR KACA LAPIS INTAN 8 MM X 60 MM	65
353-022	MATA BOR SET HSS 19 PCS (1-10MM)	69	353-301	MATA BOR BESI CO8 - FOR STAINLESS 1 MM	68
353-023	MATA BOR SET HSS 25 PCS (1-13 MM)	69	353-302	MATA BOR BESI CO8 - FOR STAINLESS 1.5 MM	68
353-030	MATA BOR BETON PANJANG 6 MM X 300 MM	64	353-303	MATA BOR BESI CO8 - FOR STAINLESS 2 MM	68
353-031	MATA BOR BETON PANJANG 8 MM X 300 MM	64	353-304	MATA BOR BESI CO8 - FOR STAINLESS 2.5 MM	68

ITEM NO.	PAGE	ITEM NO.	PAGE		
353-305	MATA BOR BESI CO8 - FOR STAINLESS 3 MM	68	354-014	PALU KONDE GAGANG FIBER 24 OZ	46
353-307	MATA BOR BESI CO8 - FOR STAINLESS 3,5 MM	68	354-015	PALU KONDE GAGANG FIBER 32 OZ	46
353-308	MATA BOR BESI CO8 - FOR STAINLESS 4 MM	68	354-021	PALU KAMBING GAGANG FIBER 8 OZ	45
353-309	MATA BOR BESI CO8 - FOR STAINLESS 4,5 MM	68	354-022	PALU KAMBING GAGANG FIBER 13 OZ	45
353-311	MATA BOR BESI CO8 - FOR STAINLESS 5 MM	68	354-023	PALU KAMBING GAGANG FIBER 16 OZ	45
353-312	MATA BOR BESI CO8 - FOR STAINLESS 5,5 MM	68	354-031	PALU KAMBING GAGANG KAYU 8 OZ	45
353-313	MATA BOR BESI CO8 - FOR STAINLESS 6 MM	68	354-033	PALU KAMBING GAGANG KAYU 16 OZ	45
353-314	MATA BOR BESI CO8 - FOR STAINLESS 6,5 MM	68	354-034	PALU KAMBING PIPA BESI 8 OZ	45
353-315	MATA BOR BESI CO8 - FOR STAINLESS 7 MM	68	354-035	PALU KAMBING PIPA BESI 13 OZ	45
353-316	MATA BOR BESI CO8 - FOR STAINLESS 7,5 MM	68	354-036	PALU KAMBING PIPA BESI 16 OZ	45
353-317	MATA BOR BESI CO8 - FOR STAINLESS 8 MM	68	354-041	PALU KONDE GAGANG KAYU 8 OZ	46
353-318	MATA BOR BESI CO8 - FOR STAINLESS 8,5 MM	68	354-042	PALU KONDE GAGANG KAYU 12 OZ	46
353-319	MATA BOR BESI CO8 - FOR STAINLESS 9 MM	68	354-043	PALU KONDE GAGANG KAYU 16 OZ	46
353-320	MATA BOR BESI CO8 - FOR STAINLESS 9,5 MM	68	354-044	PALU KONDE GAGANG KAYU 24 OZ	46
353-321	MATA BOR BESI CO8 - FOR STAINLESS 10 MM	68	354-045	PALU KONDE GAGANG KAYU 32 OZ	46
353-322	MATA BOR BESI CO8 - FOR STAINLESS 10,5 MM	68	354-051	PALU KARET GAGANG FIBER 8 OZ	44
353-323	MATA BOR BESI CO8 - FOR STAINLESS 11 MM	68	354-052	PALU KARET GAGANG FIBER 12 OZ	44
353-324	MATA BOR BESI CO8 - FOR STAINLESS 11,5 MM	68	354-053	PALU KARET GAGANG FIBER 16 OZ	44
353-325	MATA BOR BESI CO8 - FOR STAINLESS 12 MM	68	354-054	PALU KARET GAGANG FIBER 24 OZ	44
353-326	MATA BOR BESI CO8 - FOR STAINLESS 12,5 MM	68	354-063	PALU KETOK KARAT 300 G	47
353-327	MATA BOR BESI CO8 - FOR STAINLESS 13 MM	68	354-065	PALU KETOK KARAT 500 G	47
353-340	MATA BOR CHISEL 5/16" X 3/4"	57	354-066	PALU KETOK LAS 300 G	47
353-341	MATA BOR CHISEL 3/8" X 3/4"	57	354-071	PALU TUKANG 140 G	46
353-342	MATA BOR CHISEL 1/2" X 3/4"	57	354-072	PALU TUKANG 210 G	46
353-343	MATA BOR CHISEL 5/8" X 3/4"	57	354-073	PALU TUKANG 240 G	46
353-351	MATA BOR BESI H.S.S KHROM 1,0 MM	69	354-083	PALU KAMBING MIRROR POLISHED 16 OZ	45
353-352	MATA BOR BESI H.S.S KHROM 1,5 MM	69	354-084	PALU KAMBING MINI 8 OZ	46
353-353	MATA BOR BESI H.S.S KHROM 2,0 MM	69	354-101	PALU FINIL 1.0 LB	44
353-354	MATA BOR BESI H.S.S KHROM 2,5 MM	69	354-102	PALU FINIL 1.5 LB	44
353-355	MATA BOR BESI H.S.S KHROM 3,0 MM	69	354-103	PALU FINIL 2.0 LB	44
353-357	MATA BOR BESI H.S.S KHROM 3,5 MM	69	354-121	PALU BATU 2 LB X 400 GRAM	43
353-358	MATA BOR BESI H.S.S KHROM 4,0 MM	69	354-122	PALU BATU 3 LB X 400 GRAM	43
353-359	MATA BOR BESI H.S.S KHROM 4,5 MM	69	354-123	PALU BATU 4 LB X 400 GRAM	43
353-361	MATA BOR BESI H.S.S KHROM 5,0 MM	69	354-124	PALU BATU 6 LB X 400 GRAM	43
353-362	MATA BOR BESI H.S.S KHROM 5,2 MM	69	354-125	PALU BATU 8 LB X 400 GRAM	43
353-363	MATA BOR BESI H.S.S KHROM 5,5 MM	69	354-126	PALU BATU 10 LB X 400 GRAM	43
353-364	MATA BOR BESI H.S.S KHROM 6,0 MM	69	354-127	PALU BATU 12 LB X 400 GRAM	43
353-365	MATA BOR BESI H.S.S KHROM 6,5 MM	69	354-128	PALU BATU 14 LB X 400 GRAM	43
353-366	MATA BOR BESI H.S.S KHROM 7,0 MM	69	354-129	PALU BATU 16 LB X 400 GRAM	43
353-367	MATA BOR BESI H.S.S KHROM 7,5 MM	69	354-130	PALU BATU 18 LB X 400 GRAM	43
353-368	MATA BOR BESI H.S.S KHROM 8,0 MM	69	354-131	PALU BATU 20 LB X 400 GRAM	43
353-369	MATA BOR BESI H.S.S KHROM 8,5 MM	69	354-141	PALU KUNINGAN GAGANG PVC 2 LB X 280 MM	43
353-370	MATA BOR BESI H.S.S KHROM 9,0 MM	69	354-142	PALU KUNINGAN GAGANG PVC 3 LB X 300 MM	43
353-371	MATA BOR BESI H.S.S KHROM 9,5 MM	69	354-143	PALU KUNINGAN GAGANG PVC 4 LB X 320 MM	43
353-372	MATA BOR BESI H.S.S KHROM 10,0 MM	69	354-144	PALU KUNINGAN GAGANG PVC 6 LB X 610 MM	43
353-373	MATA BOR BESI H.S.S KHROM 10,5 MM	69	354-145	PALU KUNINGAN GAGANG PVC 8 LB X 820 MM	43
353-374	MATA BOR BESI H.S.S KHROM 11,0 MM	69	354-146	PALU KUNINGAN GAGANG PVC 10 LB X 820 MM	43
353-375	MATA BOR BESI H.S.S KHROM 11,5 MM	69	354-151	PALU TEMBAGA GAGANG PVC 2 LB X 280 MM	44
353-376	MATA BOR BESI H.S.S KHROM 12,0 MM	69	354-152	PALU TEMBAGA GAGANG PVC 3 LB X 300 MM	44
353-377	MATA BOR BESI H.S.S KHROM 12,5 MM	69	354-153	PALU TEMBAGA GAGANG PVC 4 LB X 320 MM	44
353-378	MATA BOR BESI H.S.S KHROM 13,0 MM	69	354-154	PALU TEMBAGA GAGANG PVC 6 LB X 620 MM	44
354			354-155	PALU TEMBAGA GAGANG PVC 8 LB X 820 MM	44
354-001	PALU BATU GAGANG FIBER 2 LB X 30 CM	43	354-156	PALU TEMBAGA GAGANG PVC 10 LB X 820 MM	44
354-002	PALU BATU GAGANG FIBER 3 LB X 35 CM	43	355		
354-003	PALU BATU GAGANG FIBER 4 LB X 40 CM	43	355-011	ALAT KEBUN SET 5 PCS	73
354-004	PALU BATU GAGANG FIBER 6 LB X 90 CM	43	355-012	ALAT KEBUN SET 3 PCS	73
354-005	PALU BATU GAGANG FIBER 8 LB X 90 CM	43	356		
354-006	PALU BATU GAGANG FIBER 10 LB X 90 CM	43	356-011	CATOK PARON 3"/5,5 KG	135
354-007	PALU BATU GAGANG FIBER 12 LB X 90 CM	43	356-012	CATOK PARON 4"/9,5 KG	135
354-008	PALU BATU GAGANG FIBER 14 LB X 90 CM	43	356-013	CATOK PARON 5"/15 KG	135
354-011	PALU KONDE GAGANG FIBER 8 OZ	46	356-014	CATOK PARON 6"/23 KG	135
354-012	PALU KONDE GAGANG FIBER 12 OZ	46	356-015	CATOK PARON 8"/37 KG	135
354-013	PALU KONDE GAGANG FIBER 16 OZ	46	356-021	CATOK F HEAVY DUTY 100 X 300 MM	134

ITEM NO.		PAGE
356-022	CATOK F HEAVY DUTY 120 X 400 MM	134
356-023	CATOK F HEAVY DUTY 120 X 500 MM	134
356-024	CATOK F HEAVY DUTY 120 X 600 MM	134
356-025	CATOK F HEAVY DUTY 120 X 800 MM	134
356-026	CATOK F HEAVY DUTY 120 X 1000 MM	134
356-027	CATOK F HEAVY DUTY 120 X 1200 MM	134
356-071	CATOK MEJA	135
356-083	CATOK PIPA NO: 2 (10 - 90 MM)	135
356-084	CATOK PIPA NO: 3 (15 - 115 MM)	135
356-085	CATOK PIPA NO: 4 (15 - 165 MM)	135
356-101	CATOK C HEAVY DUTY 4"	134
356-102	CATOK C HEAVY DUTY 5"	134
356-103	CATOK C HEAVY DUTY 6"	134
356-104	CATOK C HEAVY DUTY 8"	134
356-105	CATOK C HEAVY DUTY 10"	134
356-106	CATOK C HEAVY DUTY 12"	134
356-111	SIKU MAGNET MINI 4 PCS	134
356-112	SIKU MAGNET WELDING 3" (25LBS)	134
356-113	SIKU MAGNET WELDING 4" (50LBS)	134
356-114	SIKU MAGNET WELDING 5" (75LBS)	134
356-122	SPRING KLEM 4"	135
356-124	SPRING KLEM 6"	135
357		
357-001	TREKER 3 KAKI 3"	20
357-002	TREKER 3 KAKI 4"	20
357-003	TREKER 3 KAKI 6"	20
357-004	TREKER 3 KAKI 8"	20
357-005	TREKER 3 KAKI 10"	20
357-006	TREKER 3 KAKI 12"	20
357-007	TREKER 2 FUNGSI 4"	20
357-008	TREKER 2 FUNGSI 6"	20
357-009	TREKER 2 FUNGSI 8"	20
357-014	TREKER MAGNIT HONDA TIGER	21
357-018	TREKER MAGNIT UNIVERSAL YAMAHA RX	22
357-019	TREKER MAGNIT UNIVERSAL HONDA NEOTEX	22
357-020	TREKER MAGNIT UNIVERSAL YAMAHA FORCE-1	22
357-031	TREKER BALL JOINT	21
357-032	TREKER REM MOBIL	21
358		
358-001	STAPLES 4-8 MM	121
358-002	STAPLES 3 IN 1	121
358-005	STAPLES ANGIN F-30	1
358-007	STAPLES ANGIN 1022J	1
358-011	ISI STAPLES MODEL SQUARE 6 MM	136
358-012	ISI STAPLES MODEL SQUARE 8 MM	136
358-013	ISI STAPLES ANGIN F-10	136
358-014	ISI STAPLES ANGIN F-15	136
358-015	ISI STAPLES ANGIN F-20	136
358-016	ISI STAPLES ANGIN F-25	136
358-017	ISI STAPLES ANGIN F-30	136
358-021	STAPLES 4 IN 1	121
358-033	ISI STAPLES MODEL SQUARE 10 MM	136
358-034	ISI STAPLES MODEL SQUARE 12 MM	136
358-035	ISI STAPLES MODEL SQUARE 14 MM	136
358-043	ISI STAPLES MODEL T 10 MM	136
358-044	ISI STAPLES MODEL T 12 MM	136
358-045	ISI STAPLES MODEL T 14 MM	136
358-060	ISI STAPLES ANGIN 1006 J	136
358-061	ISI STAPLES ANGIN 1008 J	136
358-062	ISI STAPLES ANGIN 1010 J	136
358-063	ISI STAPLES ANGIN 1013 J	136
358-070	ISI STAPLES ANGIN 406 J	136
358-071	ISI STAPLES ANGIN 408 J	136

ITEM NO.		PAGE
358-072	ISI STAPLES ANGIN 410 J	136
358-073	ISI STAPLES ANGIN 413 J	136
359		
359-010	GREASE GUN MINI	8
359-011	GREASE GUN HITAM	8
359-012	GREASE GUN MERAH	8
359-031	OIL SUCTION GUN 500 CC	9
359-032	OIL CAN TABUNG TRANSPARAN 350 CC	9
359-033	OIL CAN TABUNG BESI 200 CC	9
359-034	OIL CAN TABUNG BESI 300 CC	9
359-041	POMPA OLI	10
359-042	TEST PUMP	10
359-043	POMPA OLI PVC	10
359-051	SARINGAN MINYAK PLASTIK 5,5"	169
359-052	SARINGAN MINYAK PLASTIK 6,5"	169
359-100	SELANG GREASE GUN	8
360		
360-001	ALAT SODOK LEM 9"	25
360-002	ALAT SODOK LEM NYLON 9"	25
360-003	ALAT SODOK LEM PROFESIONAL 9"	25
360-004	ALAT SODOK LEM TABUNG ALUMUNIUM 9"	25
360-005	ALAT SODOK LEM TABUNG ALUMUNIUM 15"	25
360-006	GLUE GUN 10 W	164
360-007	GLUE GUN 40 W	164
360-008	GLUE GUN 60 W	164
360-009	GLUE GUN 80 W	164
360-011	SOLDER LISTRIK GAGANG KAYU 100 W	166
360-012	SOLDER LISTRIK GAGANG KAYU 150 W	166
360-013	SOLDER LISTRIK GAGANG KAYU 200 W	166
360-014	SOLDER LISTRIK GAGANG KAYU 300 W	166
360-016	SOLDER LISTRIK GAGANG T 40 W	166
360-017	SOLDER LISTRIK GAGANG PISTOL 30 W	166
360-019	SOLDER LISTRIK GAGANG LURUS 40 W	166
360-021	GLUE STICK 100 X 7,2M	164
360-022	GLUE STICK 250 X 11,2M	164
360-101	LEM SILICONE TABUNG NETRAL BENING	26
360-102	LEM SILICONE TABUNG NETRAL HITAM	26
360-103	LEM SILICONE TABUNG NETRAL PUTIH	26
360-104	LEM SILICONE TABUNG NETRAL ABU - ABU	26
360-111	LAKBAN TALANG	26
360-114	SUPER GLUE	26
361		
361-001	SIKAT BAJA HITAM GAGANG PLASTIK	53
361-003	SIKAT BAJA GAGANG KUNING	53
361-011	SIKAT MANGKOK 3" X M10 X 1,5 -SS	138
361-012	SIKAT MANGKOK 4" X M14 X 2,0 -SS	138
361-013	SIKAT MANGKOK 3" X M10 X 1,5 STEEL	138
361-014	SIKAT MANGKOK 4" X M14 X 2,0 STEEL	138
361-015	SIKAT MANGKOK KEPANG 3" X M10 X 1,5	138
361-020	SIKAT BAJA KUNING GAGANG PLASTIK	53
361-021	SIKAT KOMBINASI 9"	53
361-022	SIKAT KOMBINASI 7"	53
361-023	ALAT PEMBERSIH KACA BODI BESI 8"	156
361-024	ALAT PEMBERSIH KACA BODI BESI 10"	156
361-025	ALAT PEMBERSIH KACA BODI BESI 12"	156
361-031	SIKAT BAJA GRENDA TANGKAI 12 X 27 MM	138
361-032	SIKAT BAJA GRENDA TANGKAI 19 X 27 MM	138
361-033	SIKAT BAJA GRENDA TANGKAI 24 X 27 MM	138
361-034	SIKAT BAJA GRENDA TANGKAI 28 X 28 MM	138
361-035	SIKAT BAJA GRENDA MANGKOK 50 MM	139
361-036	SIKAT BAJA GRENDA MANGKOK 63 MM	139
361-037	SIKAT BAJA GRENDA MANGKOK 75 MM	139
361-038	SIKAT BAJA GRENDA BULAT 38 MM	139

ITEM NO.	PAGE	ITEM NO.	PAGE		
361-039	SIKAT BAJA GREENDA BULAT 50 MM	139	363-005	GERGAJI SUDUT 2 SECTION	32
361-040	SIKAT BAJA GREENDA BULAT 63 MM	139	363-011	GERGAJI GOROK 2 SECTION 18"	33
361-041	SIKAT BAJA GREENDA BULAT 75 MM	139	363-012	GERGAJI GOROK 2 SECTION 20"	33
361-042	SIKAT BAJA GREENDA 3 PCS	139	363-021	GERGAJI GOROK GAGANG KAYU 3 SECTION 18"	33
361-043	SIKAT BAJA GREENDA 5 PCS	139	363-022	GERGAJI GOROK GAGANG KAYU 3 SECTION 20"	33
362			363-030	GERGAJI GOROK 3 SECTION 2 PCS 18" & 20"	33
362-001	GUNTING BETON 18"	34	363-031	GERGAJI GOROK GAGANG KARET 3 SECTION 18"	33
362-002	GUNTING BETON 24"	34	363-032	GERGAJI GOROK GAGANG KARET 3 SECTION 20"	33
362-003	GUNTING BETON 30"	34	363-033	GERGAJI GYPSUM 150 MM	54
362-004	GUNTING BETON 36"	34	363-041	GERGAJI BUSUR 3 IN 1	32
362-005	GUNTING BETON 42"	34	364		
362-007	ALAT STRAPING BAN PLASTIK	133	364-001	STANG GERGAJI BESI 2 IN 1	54
362-008	ALAT POTONG BETON 20 MM	48	364-002	STANG GERGAJI BESI PROFESSIONAL	54
362-009	ALAT POTONG BETON 28 MM	48	364-003	STANG GERGAJI BESI PROFESSIONAL 2 IN 1	54
362-010	ALAT POTONG BETON 32 MM	48	364-004	STANG GERGAJI BESI KHROM	55
362-021	GUNTING SENG 8"	34	364-010	STANG GERGAJI BESI MODEL OVAL GG PLASTIK	55
362-022	GUNTING SENG 10"	34	364-023	MATA GERGAJI MESIN 14" X 10 T	70
362-024	GUNTING SS GAGANG KUNING HITAM	158	364-024	MATA GERGAJI MESIN 16" X 10 T	70
362-025	GUNTING KAIN SS 8,5"	158	364-026	MATA GERGAJI BESI ENKEL 12"X 24 T	70
362-026	GUNTING SS GAGANG PVC 7"	158	365		
362-027	GUNTING SERBAGUNA	158	365-001	ALAT POTONG KERAMIK 3 IN 1 400 MM	24
362-028	GUNTING DAPUR 8,5"	159	365-002	ALAT POTONG KERAMIK HEAVY DUTY 600 MM	24
362-033	GUNTING DAHAN GAGANG KAYU	73	365-003	ALAT POTONG KERAMIK 3 IN 1 600 MM	24
362-036	GUNTING DAHAN TYPE JAPAN	73	365-004	ALAT POTONG KERAMIK LASER 1000 MM	24
362-041	ALAT POTONG PIPA TEMBAGA	80	365-101	MATA POTONG KERAMIK 3 IN 1	24
362-042	ALAT POTONG KACA TC 90	23	365-102	MATA POTONG KERAMIK HEAVY DUTY 600 MM	24
362-044	KOP KACA 3 KAKI	36	366		
362-051	ALAT PEMEKAR PIPA TEMBAGA	80	366-011	DIAMOND WHEEL BASAH 4"	63
362-054	ALAT POTONG & PEMEKAR PIPA TEMBAGA SET	80	366-012	DIAMOND WHEEL KERING 4"	63
362-055	PISAU PEMOTONG SERBAGUNA	159	366-013	DIAMOND GRINDING WHEEL DOUBLE 4"	59
362-056	PISAU CUTTER 3 BLADE	160	366-014	DIAMOND GRINDING WHEEL DOUBLE 5"	59
362-059	PISAU SADAP KARET	79	366-015	DIAMOND WHEEL SUPER THIN	63
362-060	PISAU LIPAT 5 BLADE	160	366-101	MULTICUTTER 4" X 40 T	59
362-061	PISAU CUTTER 5 BLADE	160	366-111	DIAMOND WHEEL TURBO 4"	63
362-062	PISAU CUTTER 2 PCS	160	366-201	DIAMOND CUP WHEEL 100 MM	59
362-065	PISAU LIPAT 12 IN 1	161	366-202	DIAMOND CUP WHEEL 75 MM	59
362-070	MATA POTONG BETON 20 MM	48	367		
362-071	MATA POTONG BETON 28 MM	48	367-001	SKETMAT BESI 6"	120
362-072	MATA POTONG BETON 32 MM	48	367-002	SKETMAT BESI 8"	120
362-073	PISAU BUBUT 1/4 X 4"	70	367-003	SKETMAT DIGITAL 6"	120
362-074	PISAU BUBUT 5/16 X 4"	70	367-006	SKETMAT BESI 12"	120
362-075	PISAU BUBUT 3/8 X 4"	70	367-007	SKETMAT DIAL 6"	120
362-076	PISAU BUBUT 1/2 X 4"	70	367-020	WATERPASS ALUMINIUM KUNING 80"	42
362-077	PISAU BUBUT 5/8 X 4"	70	367-021	WATERPASS MAGNET HEAVY DUTY 18"	42
362-083	PISAU BUBUT 1/4 X 6"	70	367-022	WATERPASS MAGNET HEAVY DUTY 24"	42
362-084	PISAU BUBUT 5/16 X 6"	70	367-041	WATERPASS TORPEDO 9"	42
362-085	PISAU BUBUT 3/8 X 6"	70	367-051	MIKROMETER 0 - 25 MM	120
362-086	PISAU BUBUT 1/2 X 6"	70	367-052	MIKROMETER 25 - 50 MM	120
362-087	PISAU BUBUT 5/8 X 6"	70	367-053	MIKROMETER 50 - 75 MM	120
362-090	GUNTING KABEL 10"	132	367-054	MIKROMETER 75 - 100 MM	120
362-100	GUNTING 6,5"	159	367-090	TIMBANGAN GANTUNG 25 KG	169
362-102	GUNTING SS 250 MM	159	367-091	TIMBANGAN GANTUNG 50 KG	169
362-112	GUNTING SENG & GALVALUM MODEL LURUS	34	367-092	TIMBANGAN GANTUNG 100 KG	169
362-141	PISAU POTONG RUMPUT	62	367-101	TIMBANGAN KUE + PIRINGAN STAINLESS 5 KG	169
362-142	PISAU POTONG RUMPUT BULAT	62	367-102	TIMBANGAN KUE + PIRINGAN STAINLESS 10 KG	169
362-151	GUNTING RUMPUT 3 POSISI	74	367-103	TIMBANGAN KUE + PIRINGAN STAINLESS 15 KG	169
362-201	PLONG KULIT SET 5 PCS	119	367-104	TIMBANGAN KUE + PIRINGAN STAINLESS 20 KG	169
362-202	PLONG KULIT SET 12 PCS	119	367-106	FULLER BLADE 13 PCS	12
362-666	REFILL PISAU CUTTER 10 PCS	161	368		
363			368-001	METERAN FIBER 30 M	40
363-001	GERGAJI TANGKAI MODEL LIPAT	74	368-002	METERAN FIBER 50 M	40
363-003	GERGAJI 5 IN 1	32	368-003	METERAN FIBER 100 M	40
363-004	GERGAJI DAHAN GAGANG ORANGE	74	368-022	METERAN ROL KUNING 5 M X 19 MM	40

ITEM NO.		PAGE
368-023	METERAN ROL KUNING 7,5 M X 25 MM	40
368-027	METERAN ROL BODI KARET 5 M X 19 MM	40
368-028	METERAN ROL BODI KARET 7,5 M X 25 MM	40
368-041	METERAN JALAN	41
368-210	PENGGARIS BENANG + KAPUR + WATERPASS	49
369		
369-001	BATU OSCO 5 PCS	30
369-002	BATU OSCO 10 PCS	30
369-003	BATU ASAH PISAU KETAM	30
369-005	BATU POTONG 4" X 1,2 MM	140
369-006	BATU POTONG 4" X 2 MM	140
369-008	BATU POTONG 14" X 3,2 MM	140
369-013	BATU GOSOK ABU-ABU 6"	30
369-014	BATU GOSOK ABU-ABU 8"	30
369-016	BATU GURINDA 4" X 6 X 16 MM	140
369-027	BATU GURINDA ABU-ABU 6" X 1 X 1 & 1 1/4 - A60	141
369-037	BATU GURINDA ABU-ABU 12" X 1 1/2 X 1 1/4 - A46	141
369-039	BATU GURINDA HIJAU 6" X 1 X 1 & 1 1/4 - GC80	141
369-040	BATU GURINDA HIJAU 6" X 1 X 1 & 1 1/4 - GC100	141
369-091	AMPLAS KAIN WATERPROOF # 0	27
369-092	AMPLAS KAIN WATERPROOF # 1	27
369-093	AMPLAS KAIN WATERPROOF # 1.5	27
369-094	AMPLAS KAIN WATERPROOF # 2	27
369-095	AMPLAS KAIN WATERPROOF # 2.5	27
369-096	AMPLAS KAIN WATERPROOF # 3	27
369-100	AMPLAS BULAT 4" #16	28
369-101	AMPLAS BULAT 4" #24	28
369-102	AMPLAS BULAT 4" #36	28
369-104	AMPLAS BULAT 4" #60	28
369-105	AMPLAS BULAT 4" #80	28
369-106	AMPLAS BULAT 4" #100	28
369-107	AMPLAS BULAT 4" #120	28
369-108	AMPLAS BULAT 4" #150	28
369-111	AMPLAS KERTAS # 100	27
369-112	AMPLAS KERTAS # 120	27
369-113	AMPLAS KERTAS # 150	27
369-114	AMPLAS KERTAS # 180	27
369-115	AMPLAS KERTAS # 220	27
369-116	AMPLAS KERTAS # 240	27
369-117	AMPLAS KERTAS # 280	27
369-118	AMPLAS KERTAS # 320	27
369-119	AMPLAS KERTAS # 360	27
369-120	AMPLAS KERTAS # 400	27
369-121	AMPLAS KERTAS # 500	27
369-122	AMPLAS KERTAS # 600	27
369-123	AMPLAS KERTAS # 800	27
369-124	AMPLAS KERTAS # 1000	27
369-131	AMPLAS ROL 4" X 40 M #40	28
369-133	AMPLAS ROL 4" X 40 M #60	28
369-134	AMPLAS ROL 4" X 40 M #80	28
369-135	AMPLAS ROL 4" X 40 M #100	28
369-136	AMPLAS ROL 4" X 40 M #120	28
369-137	AMPLAS ROL 4" X 40 M #150	28
369-138	AMPLAS ROL 4" X 40 M #180	28
369-139	AMPLAS ROL 4" X 40 M #220	28
369-140	AMPLAS ROL 4" X 40 M #240	28
369-142	AMPLAS ROL 2" X 50 M #80	28
369-143	AMPLAS ROL 2" X 50 M #100	28
369-144	AMPLAS ROL 2" X 50 M #120	28
369-145	AMPLAS ROL 2" X 50 M #150	28
369-146	AMPLAS ROL 2" X 50 M #180	28
369-147	AMPLAS ROL 2" X 50 M #220	28
369-148	AMPLAS ROL 2" X 50 M #240	28

ITEM NO.		PAGE
369-151	AMPLAS BULAT VELCRO 4" #36	29
369-152	AMPLAS BULAT VELCRO 4" #60	29
369-153	AMPLAS BULAT VELCRO 4" #80	29
369-154	AMPLAS BULAT VELCRO 4" #100	29
369-155	AMPLAS BULAT VELCRO 4" #120	29
369-156	AMPLAS BULAT VELCRO 4" #150	29
369-157	AMPLAS BULAT VELCRO 4" #180	29
369-158	AMPLAS BULAT VELCRO 4" #240	29
369-193	FLAP DISC 4" # 60	29
369-194	FLAP DISC 4" # 80	29
369-195	FLAP DISC 4" # 100	29
369-196	FLAP DISC 4" # 120	29
371		
371-001	MATA BEADING BIT TCT 1/4" X 5/32"	60
371-002	MATA BEADING BIT TCT 1/4" X 3/16"	60
371-003	MATA BEADING BIT TCT 1/4" X 1/4"	60
371-004	MATA BEADING BIT TCT 1/4" X 5/16"	60
371-011	MATA SLOTTING BIT TCT 1/4" X 3 MM	60
371-012	MATA SLOTTING BIT TCT 1/4" X 4 MM	60
371-013	MATA SLOTTING BIT TCT 1/4" X 5 MM	60
371-014	MATA SLOTTING BIT TCT 1/4" X 6 MM	60
371-015	MATA SLOTTING BIT TCT 1/4" X 8 MM	60
371-021	MATA STRAIGHT BIT TCT 1/4" X 3 MM	60
371-022	MATA STRAIGHT BIT TCT 1/4" X 4 MM	60
371-023	MATA STRAIGHT BIT TCT 1/4" X 5 MM	60
371-024	MATA STRAIGHT BIT TCT 1/4" X 6 MM	60
371-025	MATA STRAIGHT BIT TCT 1/4" X 8 MM	60
371-032	MATA CLASSICAL COVE BIT TCT 1/4" X 3/16"	60
371-033	MATA CLASSICAL COVE BIT TCT 1/4" X 1/4"	60
371-034	MATA CLASSICAL COVE BIT TCT 1/4" X 5/16"	60
371-042	MT CLASSICAL ROMAN OGEE BIT TCT 1/4" X 3/16"	61
371-043	MT CLASSICAL ROMAN OGEE BIT TCT 1/4" X 1/4"	61
371-044	MT CLASSICAL ROMAN OGEE BIT TCT 1/4" X 5/16"	61
371-052	MATA ROMAN OGEE BIT TCT 1/4" X 3/16"	61
371-053	MATA ROMAN OGEE BIT TCT 1/4" X 1/4"	61
371-054	MATA ROMAN OGEE BIT TCT 1/4" X 5/16"	61
371-062	MATA CLASSICAL OGEE BIT TCT 1/4" X 3/16"	61
371-063	MATA CLASSICAL OGEE BIT TCT 1/4" X 1/4"	61
371-064	MATA CLASSICAL OGEE BIT TCT 1/4" X 5/16"	61
371-072	MATA COVE BIT TCT 1/4" X 3/16"	61
371-073	MATA COVE BIT TCT 1/4" X 1/4"	61
371-074	MATA COVE BIT TCT 1/4" X 5/16"	61
371-101	AUGER BIT 5/16" X 200 MM	57
371-102	AUGER BIT 5/16" X 300 MM	57
371-103	AUGER BIT 3/8" X 200 MM	57
371-104	AUGER BIT 3/8" X 300 MM	57
371-105	AUGER BIT 1/2" X 200 MM	57
371-106	AUGER BIT 1/2" X 300 MM	57
371-107	AUGER BIT 5/8" X 200 MM	57
371-108	AUGER BIT 5/8" X 300 MM	57
371-109	AUGER BIT 2 FUNGSI 3/8 X 400 MM	57
371-110	AUGER BIT 2 FUNGSI 1/2 X 400 MM	57
371-111	AUGER BIT 2 FUNGSI 5/8 X 400 MM	57
371-112	AUGER BIT 2 FUNGSI 3/4 X 400 MM	57
371-120	ADJUSTABLE HOLE CUTTER CERAMIC 20-94 MM	65
371-121	HOLE SAW SET 7 BLADE 25 MM	58
371-122	HOLE SAW SET 7 BLADE 50 MM	58
371-123	ADJUSTABLE HOLE DRILLS WOOD 30 - 120 MM	58
371-125	HOLE SAW KAYU 11 PCS	58
371-126	HOLE SAW BESI 13 PCS	66
371-131	HOLE CUTTER BESI HSS 16 MM	66
371-132	HOLE CUTTER BESI HSS 19 MM	66
371-133	HOLE CUTTER BESI HSS 20 MM	66

ITEM NO.	PAGE	ITEM NO.	PAGE
371-134	66	371-134	66
371-135	66	371-135	66
371-136	66	371-136	66
371-137	66	371-137	66
371-138	66	371-138	66
371-139	66	371-139	66
371-140	66	371-140	66
371-141	66	371-141	66
371-142	66	371-142	66
371-210	23	371-210	23
371-241	55	371-241	55
371-242	55	371-242	55
371-243	55	371-243	55
371-244	55	371-244	55
371-245	55	371-245	55
371-246	55	371-246	55
371-247	55	371-247	55
371-248	55	371-248	55
372		376	
372-001	4	376-003	168
372-006	4	376-004	168
372-007	4	376-008	168
372-008	4	376-011	157
372-009	5	376-012	157
372-010	5	377	
372-011	10	377-001	38
373		377-002	38
373-001	2	377-003	38
373-002	2	377-004	38
373-003	2	377-005	38
373-011	3	377-006	38
373-031	15	377-007	38
373-040	17	377-008	39
373-041	17	377-009	39
373-102	7	377-010	39
373-103	7	377-011	38
373-104	7	377-012	38
373-110	18	377-013	38
373-111	18	377-014	38
373-113	7	377-015	38
373-114	7	377-016	38
373-115	7	377-017	38
373-116	7	377-019	39
373-202	3	377-020	38
373-203	3	377-021	38
373-205	3	377-022	38
373-304	133	377-023	38
373-401	137	377-024	38
373-500	17	377-025	38
373-501	17	377-031	35
373-502	17	377-036	35
373-503	17	377-037	35
373-504	17	377-038	35
373-505	29	377-039	35
373-506	27	377-040	35
373-507	17	377-042	35
373-508	29	377-043	35
374		377-044	35
374-003	137	377-045	35
374-004	137	377-046	35
374-005	137	377-061	156
374-006	137	377-062	156
374-008	137	377-068	50
		377-069	50
		377-070	50
		377-071	50
		377-072	50
		377-073	50
		377-074	50
		377-075	50
		377-076	50
		377-077	50
		377-078	50
		377-079	50
		377-081	38
		377-082	38
		377-083	38
		377-084	38
		377-101	5
		377-102	5
		377-103	6

ITEM NO.	PAGE	ITEM NO.	PAGE
377-104	6	378-192	179
377-105	6	378-201	142
377-106	6	378-202	142
377-111	5	378-203	142
377-171	52	378-204	142
377-172	52	378-205	142
377-222	41	378-206	142
377-223	41	378-220	154
377-231	56	378-222	142
377-232	56	378-223	142
377-233	56	378-301	36
377-234	56	378-302	36
377-235	56	378-303	37
377-236	56	378-304	37
377-241	56	378-305	37
377-242	56	380	
377-243	56	380-021	152
377-244	56	380-022	152
377-246	56	380-023	152
377-247	56	380-024	152
377-248	56	380-025	152
377-249	56	380-026	152
378		380-027	152
378-001	75	380-028	152
378-002	75	380-029	153
378-003	75	380-030	153
378-004	76	380-031	153
378-006	77	380-032	153
378-007	76	380-033	153
378-008	76	380-034	153
378-009	76	380-035	153
378-014	77	380-036	153
378-015	77	380-037	153
378-021	78	381	
378-022	78	381-021	143
378-025	79	381-022	143
378-026	79	381-023	143
378-027	79	381-031	143
378-029	78	381-032	143
378-038	77	381-033	143
378-041	143	381-051	144
378-042	143	381-052	144
378-043	143	381-053	144
378-044	143	381-056	144
378-045	143	381-057	144
378-046	143	381-058	144
378-047	143	381-061	144
378-048	143	381-062	144
378-049	143	381-063	144
378-050	143	381-066	144
378-051	143	381-067	144
378-081	172	381-068	144
378-082	172	383	
378-083	172	383-003	176
378-084	172	383-041	179
378-085	172	383-044	179
378-086	172	383-053	174
378-101	172	383-062	176
378-102	168	383-063	176
378-107	157	383-074	174
378-108	157	383-076	175
378-109	157	383-077	175
378-110	157	383-078	175

ITEM NO.			ITEM NO.		PAGE
383-081	KACAMATA SAFETY ANTI KABUT	174	385-213	TALI PROPYLENE 10 MM X 220 M	145
384			385-214	TALI PROPYLENE 12 MM X 220 M	145
384-001	SARUNG TANGAN LAS KULIT MERAH 14"	180	385-215	TALI PROPYLENE 14 MM X 220 M	145
384-002	SARUNG TANGAN LAS KULIT BIRU 14"	180	385-216	TALI PROPYLENE 16 MM X 220 M	145
384-003	SARUNG TANGAN LAS KULIT KUNING 16"	180	385-217	TALI PROPYLENE 18 MM X 220 M	145
384-004	SARUNG TANGAN PVC COKLAT	177	385-218	TALI PROPYLENE 20 MM X 220 M	145
384-005	SARUNG TANGAN PVC BIRU	177	385-219	TALI PROPYLENE 22 MM X 220 M	145
384-008	SARUNG TANGAN LAS KULIT BIRU 18"	180	385-220	TALI PROPYLENE 24 MM X 220 M	145
385			385-221	TALI PROPYLENE 28 MM X 220 M	145
385-070	WEBBING SLING 1 T X 1 M UNGU	146	385-222	TALI PROPYLENE 30 MM X 220 M	145
385-071	WEBBING SLING 1 T X 2 M UNGU	146	385-223	TALI PROPYLENE 32 MM X 220 M	145
385-072	WEBBING SLING 1 T X 3 M UNGU	146	385-224	TALI PROPYLENE 36 MM X 220 M	145
385-073	WEBBING SLING 1 T X 4 M UNGU	146	385-231	TALI PP MULTIFILAMENT 6 MM x 220 M	145
385-074	WEBBING SLING 1 T X 5 M UNGU	146	385-232	TALI PP MULTIFILAMENT 8 MM x 220 M	145
385-075	WEBBING SLING 1 T X 6 M UNGU	146	385-233	TALI PP MULTIFILAMENT 10 MM x 220 M	145
385-076	WEBBING SLING 1 T X 8 M UNGU	146	385-234	TALI PP MULTIFILAMENT 12 MM x 220 M	145
385-077	WEBBING SLING 1 T X 10 M UNGU	146	385-235	TALI PP MULTIFILAMENT 14 MM x 220 M	145
385-078	WEBBING SLING 2 T X 1 M HIJAU	146	385-236	TALI PP MULTIFILAMENT 16 MM x 220 M	145
385-079	WEBBING SLING 2 T X 2 M HIJAU	146	385-237	TALI PP MULTIFILAMENT 18 MM x 220 M	145
385-080	TALI PENGIKAT BAK TRUK 2" X 6 M	14	385-238	TALI PP MULTIFILAMENT 20 MM x 220 M	145
385-081	TALI PENGIKAT BAK TRUK 2" X 8 M	14	385-239	TALI PP MULTIFILAMENT 22 MM x 220 M	145
385-082	TALI PENGIKAT BAK TRUK 2" X 10 M	14	385-240	TALI PP MULTIFILAMENT 24 MM x 220 M	145
385-083	TALI PENGIKAT BAK TRUK 2" X 12 M	14	385-241	TALI PP MULTIFILAMENT 28 MM x 220 M	145
385-085	WEBBING SLING 2 T X 3 M HIJAU	146	385-242	TALI PP MULTIFILAMENT 30 MM x 220 M	145
385-086	WEBBING SLING 2 T X 4 M HIJAU	146	385-243	TALI PP MULTIFILAMENT 32 MM x 220 M	145
385-087	WEBBING SLING 2 T X 5 M HIJAU	146	385-244	TALI PP MULTIFILAMENT 36 MM x 220 M	145
385-088	WEBBING SLING 2 T X 6 M HIJAU	146	385-245	TALI PP MULTIFILAMENT 40 MM x 220 M	145
385-089	WEBBING SLING 2 T X 8 M HIJAU	146	386		
385-090	WEBBING SLING 3 T X 4 M KUNING	146	386-011	KABEL TIE 30 M	162
385-091	WEBBING SLING 3 T X 5 M KUNING	146	386-012	KABEL TIE 50 M	162
385-092	WEBBING SLING 3 T X 6 M KUNING	146	386-014	KABEL TIE 100 M	162
385-093	WEBBING SLING 3 T X 8 M KUNING	146	386-022	KABEL AKI 200 A X 2,5 M	13
385-094	WEBBING SLING 4 T X 4 M ABU-ABU	146	386-023	KABEL AKI 300 A X 2,5 M	13
385-095	WEBBING SLING 4 T X 5 M ABU-ABU	146	386-031	KABEL TIE 5 WARNA 2,5X100MM(200PCS)	162
385-096	WEBBING SLING 4 T X 6 M ABU-ABU	146	386-032	KABEL TIE 5 WARNA 2,5X150MM(250PCS)	162
385-097	WEBBING SLING 5 T X 4 M MERAH	146	386-033	KABEL TIE 5 WARNA 3,5X200MM(100PCS)	162
385-098	WEBBING SLING 5 T X 6 M MERAH	146	386-034	KABEL TIE 5 WARNA 4,5X250MM(50PCS)	162
385-099	WEBBING SLING 6 T X 4 M COKLAT	146	386-035	KABEL TIE PUTIH 2,5 X 100 MM	162
385-100	WEBBING SLING 6 T X 6 M COKLAT	146	386-059	SENER LED 10 W	167
385-101	SABUK PENGAMAN	178	386-061	KABEL TIE PUTIH 2,5 X 150 MM	162
385-102	SABUK PENGAMAN FULL BODY	178	386-062	KABEL TIE PUTIH 3,5 X 200 MM	162
385-103	SABUK PENGAMAN FULL BODY HOOK BESAR	178	386-063	KABEL TIE PUTIH 4,5 X 250 MM	162
385-104	TALI PP SABUK PENGAMAN	178	386-064	KABEL TIE PUTIH 4,5 X 300 MM	162
385-121	WEBBING SLING 4 T X 3 M ABU-ABU	146	386-065	KABEL TIE MERAH 2,5 X 100 MM	163
385-122	WEBBING SLING 4 T X 8 M ABU-ABU	146	386-066	KABEL TIE MERAH 2,5 X 150 MM	163
385-131	WEBBING SLING 5 T X 3 M MERAH	146	386-067	KABEL TIE MERAH 3,5 X 200 MM	163
385-132	WEBBING SLING 5 T X 5 M MERAH	146	386-068	KABEL TIE MERAH 4,5 X 250 MM	163
385-141	WEBBING SLING 3 T X 3 M KUNING	146	386-069	KABEL TIE MERAH 4,5 X 300 MM	163
385-142	WEBBING SLING 3 T X 10 M KUNING	146	386-070	KABEL TIE KUNING 2,5 X 100 MM	163
385-151	WEBBING SLING 6 T X 3 M COKLAT	146	386-071	KABEL TIE KUNING 2,5 X 150 MM	163
385-152	WEBBING SLING 6 T X 5 M COKLAT	146	386-072	KABEL TIE KUNING 3,5 X 200 MM	163
385-153	WEBBING SLING 6 T X 8 M COKLAT	146	386-073	KABEL TIE KUNING 4,5 X 250 MM	163
385-156	WEBBING SLING 8 T X 6 M BIRU	146	386-074	KABEL TIE KUNING 4,5 X 300 MM	163
385-161	WEBBING SLING 10 T X 6 M ORANGE	146	386-075	KABEL TIE HIJAU 2,5 X 100 MM	163
385-162	WEBBING SLING 10 T X 8 M ORANGE	146	386-076	KABEL TIE HIJAU 2,5 X 150 MM	163
385-163	WEBBING SLING 10 T X 10 M ORANGE	146	386-077	KABEL TIE HIJAU 3,5 X 200 MM	163
385-171	TALI NYLON 6 MM X 20 M	171	386-078	KABEL TIE HIJAU 4,5 X 250 MM	163
385-172	TALI NYLON 8 MM X 20 M	171	386-079	KABEL TIE HIJAU 4,5 X 300 MM	163
385-173	TALI NYLON 10 MM X 20 M	171	386-080	KABEL TIE HITAM 2,5 X 100 MM	163
385-181	TRIMER LINE MODEL KOTAK	62	386-081	KABEL TIE HITAM 2,5 X 150 MM	163
385-182	KEPALA TRIMMER LINE	62	386-082	KABEL TIE HITAM 3,5 X 200 MM	163
385-211	TALI PROPYLENE 6 MM X 220 M	145	386-083	KABEL TIE HITAM 4,5 X 250 MM	163
385-212	TALI PROPYLENE 8 MM X 220 M	145	386-084	KABEL TIE HITAM 4,5 X 300 MM	163

ITEM NO.		PAGE
386-401	HIDROMETER AIR AKI	13
387		
387-001	DONGKRAK BOTOL 2 TON	11
387-002	DONGKRAK BOTOL 4 TON	11
387-003	DONGKRAK BOTOL 6 TON	11
387-004	DONGKRAK BOTOL 10 TON	11
387-005	DONGKRAK BOTOL 16 TON	11
387-006	DONGKRAK BOTOL 20 TON	11
387-007	DONGKRAK BOTOL 30 TON	11
387-008	DONGKRAK BOTOL 50 TON	11
387-010	DONGKRAK BUAYA 2 TON	11
387-017	DONGKRAK BUAYA HEAVY DUTY 3 TON	11
387-052	GANJALAN DONGKRAK 3 TON	11
387-053	GANJALAN DONGKRAK 6 TON	11
387-095	KATROL BESI OPEN 3" X 0.5 TON	147
387-096	KATROL BESI OPEN 4" X 1.0 TON	147
387-097	KATROL BESI OPEN 5" X 2.0 TON	147
387-098	KATROL BESI OPEN 6" X 3.2 TON	147
387-099	KATROL BESI OPEN 8" X 5.0 TON	147
387-102	KATROL HEAVY DUTY 1 T X 3 M	148
387-104	KATROL HEAVY DUTY 2 T X 3 M	148
387-105	KATROL HEAVY DUTY 3 T X 3 M	148
387-106	KATROL HEAVY DUTY 5 T X 3 M	148
387-112	KATROL HEAVY DUTY 1 T X 5 M	148
387-114	KATROL HEAVY DUTY 2 T X 5 M	148
387-115	KATROL HEAVY DUTY 3 T X 5 M	148
387-116	KATROL HEAVY DUTY 5 T X 5 M	148
387-117	KATROL HEAVY DUTY 10 T X 5 M	148
387-201	CARGO HOOK ALLOY STEEL 0.5 TON	147
387-202	CARGO HOOK ALLOY STEEL 0.75 TON	147
387-203	CARGO HOOK ALLOY STEEL 1.0 TON	147
387-204	CARGO HOOK ALLOY STEEL 2.0 TON	147
387-205	CARGO HOOK ALLOY STEEL 3.0 TON	147
387-206	CARGO HOOK ALLOY STEEL 5.0 TON	147
387-207	CARGO HOOK ALLOY STEEL 10.0 TON	147
387-210	KATROL HEAVY DUTY 2 T X 10 M	148
387-211	KATROL HEAVY DUTY 3 T X 10 M	148
387-212	KATROL HEAVY DUTY 5 T X 10 M	148
387-213	KATROL HEAVY DUTY 10 T X 10 M	148
387-221	ELECTRIC HOIST 0.5 T X 930 W	148
387-222	ELECTRIC HOIST 1.0 T X 1.700 W	148
387-231	ELECTRIC CHAIN HOIST 1T X 6 M	149
387-232	ELECTRIC CHAIN HOIST 2T X 6 M	149
387-233	ELECTRIC CHAIN HOIST 3T X 6 M	149
387-234	ELECTRIC CHAIN HOIST 1T X 12 M	149
387-236	ELECTRIC CHAIN HOIST 3T X 12 M	149
387-242	PLAIN TROLLEY 2 T	150
387-243	PLAIN TROLLEY 3 T	150
387-244	PLAIN TROLLEY 5 T	150
387-251	GEAR TROLLEY 1T X 3 M	149
387-252	GEAR TROLLEY 2T X 3 M	149
387-253	GEAR TROLLEY 3T X 3 M	149
387-254	GEAR TROLLEY 5T X 3 M	149
387-266	HORIZONTAL LIFTING CLAMP 0.75 T	150
387-267	HORIZONTAL LIFTING CLAMP 1.5 T	150
387-268	HORIZONTAL LIFTING CLAMP 2.0 T	150
387-273	VERTICAL LIFTING CLAMP 3 T	150
387-274	VERTICAL LIFTING CLAMP 5 T	150
387-303	LEVER BLOCK 1.5 T X 1.5 M	148
387-304	LEVER BLOCK 3.0 T X 1.5 M	148
388		
388-101	ALAT POTONG & GERGAJI BIJI COKLAT	74

ITEM NO.		PAGE
390		
390-001	TREKER BEARING AB-1	20
390-002	TREKER BEARING AB-2	20
390-011	PISTON RING NO. 3 (5"X 75MM)	18
390-012	PISTON RING NO. 4 (7"X100MM)	18
390-013	PISTON RING NO. 7 (50-150 MM)	18
390-016	O-RING SET 407 PCS 3 MM - 50 MM	16
390-017	O-RING SET 407 PCS 1/8" - 2"	16
390-018	O-RING SET 225 PCS 3 MM - 22 MM	16
390-019	O-RING SET 225 PCS 3/32" - 3/4"	16
391		
391-005	TOOL BOX 2 SUSUN KUNING 15"	19
391-006	TOOL BOX 2 SUSUN KUNING 20"	19
391-018	TOOL BOX PLASTIK 15"	19
391-019	TOOL BOX PLASTIK 12"	19
391-022	OBENG KACAMATA 12 IN 1 13 PCS	115
391-023	TOOL SET 100 PCS	19
392		
392-001	LAMPU KERJA	13
392-002	LAMPU SOROT LED 13 PCS	167
392-003	LAMPU SENTER KEPALA LED 8 PCS	167
392-004	LAMPU SENTER KEPALA 5 W	167
393		
393-004	KETOK ANGKA 4 MM	154
393-005	KETOK ANGKA 5 MM	154
393-009	KETOK ANGKA 12 MM	154
393-103	KETOK HURUF 3 MM	154
393-104	KETOK HURUF 4 MM	154
393-108	KETOK HURUF 10 MM	154
394		
394-010	SEAL TAPE 1/2" X 10 M X 0.075 MM	49
394-011	SEAL TAPE 3/4" X 15 M X 0.2 MM	49
394-013	SEAL TAPE 1 "X 15 M X 0.075 MM	49
394-026	POLICELINE 2"X300M (HITAM KUNING)	177
394-027	POLICELINE 3"X300M (HITAM KUNING)	177
394-028	POLICELINE 2"X300M (PUTIH MERAH)	177
394-029	POLICELINE 3"X300M (PUTIH MERAH)	177
395		
395-001	RECOIL HOSE PU 6 M	137
395-002	RECOIL HOSE PU 9 M	137
395-003	RECOIL HOSE PU 12 M	137
397		
397-001	AVOMETER YX-360-TRD	165
397-002	AVOMETER SP-15-D	165
397-003	MULTITESTER DIGITAL	165
398		
398-021	KLEM SELANG STAINLESS TUAS NYLON 5/8"	170
398-022	KLEM SELANG STAINLESS TUAS NYLON 3/4"	170
398-023	KLEM SELANG STAINLESS TUAS NYLON 7/8"	170
398-024	KLEM SELANG STAINLESS TUAS NYLON 1"	170
398-025	KLEM SELANG STAINLESS TUAS NYLON 1 1/4"	170
398-026	KLEM SELANG STAINLESS TUAS NYLON 1 1/2"	170
399		
399-002	TAP BALIK 6 PCS	71
399-003	TAP & DIE SET 40 PCS	71
399-004	TAP & DIE SET 20 PCS	71
399-007	STANG TAP M1-10	72
399-008	STANG TAP M4-12	72
399-009	STANG TAP M5-20	72
399-011	HAND TAP 3 PCS 3 MM X 0,5	72
399-012	HAND TAP 3 PCS 4 MM X 0,7	72
399-013	HAND TAP 3 PCS 5 MM X 0,8	72
399-014	HAND TAP 3 PCS 6 MM X 1,0	72

ITEM NO.		PAGE
399-015	HAND TAP 3 PCS 7 MM X 1,0	72
399-016	HAND TAP 3 PCS 8 MM X 1,0	72
399-017	HAND TAP 3 PCS 8 MM X 1,25	72
399-018	HAND TAP 3 PCS 10 MM X 1,0	72
399-019	HAND TAP 3 PCS 10 MM X 1,25	72
399-020	HAND TAP 3 PCS 10 MM X 1,5	72
399-021	HAND TAP 3 PCS 12 MM X 1,25	72
399-022	HAND TAP 3 PCS 12 MM X 1,5	72
399-023	HAND TAP 3 PCS 12 MM X 1,75	72
399-024	HAND TAP 3 PCS 14 MM X 1,25	72
399-025	HAND TAP 3 PCS 14 MM X 1,5	72
399-026	HAND TAP 3 PCS 14 MM X 2,0	72
399-027	HAND TAP 3 PCS 16 MM X 1,25	72
399-028	HAND TAP 3 PCS 16 MM X 1,5	72
399-029	HAND TAP 3 PCS 16 MM X 2,0	72
399-051	HAND TAP 3 PCS 1/8" X 40	72
399-052	HAND TAP 3 PCS 3/16" X 24	72
399-053	HAND TAP 3 PCS 1/4" X 20	72
399-054	HAND TAP 3 PCS 5/16" X 18	72
399-055	HAND TAP 3 PCS 3/8" X 16	72
399-056	HAND TAP 3 PCS 1/2" X 12	72
399-057	HAND TAP 3 PCS 5/8" X 11	72
399-061	TAP BALIK KRAN AIR	71

ITEM NO.	PAGE
----------	------

DIRECTORY 2023

INDEX SORT BY ALPHABETICAL

ITEM NO.		PAGE
A		
371-120	ADJUSTABLE HOLE CUTTER CERAMIC 20-94 MM	65
371-123	ADJUSTABLE HOLE DRILLER WOOD 30 - 120 MM	58
372-009	AIR BLOW GUN 100 MM	05
372-010	AIR BLOW GUN 250 MM	05
373-011	AIR CHUCK TD-11	03
372-001	AIR DUSTER 3 IN 1	04
372-006	AIR DUSTER DG - 10 - 1	04
372-007	AIR DUSTER DG - 10 - 2	04
372-008	AIR DUSTER DG - 10 - 3	04
351-109	AKSESORIS KLEM KABEL PVC	155
351-105	AKSESORIS SEKRUUP KAYU	155
345-211	ALAS MEKANIK 40"	14
347-501	ALAT CABUT PAKU 12 MM X 300 MM	23
347-502	ALAT CABUT PAKU 16 MM X 450 MM	23
347-503	ALAT CABUT PAKU 16 MM X 600 MM	23
345-020	ALAT JEPIT SERBAGUNA 450 MM	156
345-021	ALAT JEPIT SERBAGUNA 600 MM	156
355-012	ALAT KEBUN SET 3 PCS	73
355-011	ALAT KEBUN SET 5 PCS	73
347-114	ALAT PEMBENGKOK PIPA TEMBAGA 3 IN 1	80
361-023	ALAT PEMBERSIH KACA BODI BESI 8"	156
361-024	ALAT PEMBERSIH KACA BODI BESI 10"	156
361-025	ALAT PEMBERSIH KACA BODI BESI 12"	156
377-061	ALAT PEMBERSIH KACA BODI PVC 10"	156
377-062	ALAT PEMBERSIH KACA BODI PVC 12"	156
378-110	ALAT PEMBERSIH SALURAN PIPA + HANDLE	157
378-109	ALAT PEMBERSIH SALURAN PIPA PLAT 25 FT	157
378-107	ALAT PEMBERSIH SALURAN PIPA SPIRAL 3 M	157
378-108	ALAT PEMBERSIH SALURAN PIPA SPIRAL 5 M	157
362-051	ALAT PEMEKAR PIPA TEMBAGA	80
373-102	ALAT PENGUNGKIT BAN 10"	07
373-103	ALAT PENGUNGKIT BAN 12"	07
373-104	ALAT PENGUNGKIT BAN 16"	07
388-101	ALAT POTONG & GERGAJI BIJI COKLAT	74
362-054	ALAT POTONG & PEMEKAR PIPA TEMBAGA SET	80
362-008	ALAT POTONG BETON 20 MM	48
362-009	ALAT POTONG BETON 28 MM	48
362-010	ALAT POTONG BETON 32 MM	48
362-042	ALAT POTONG KACA TC 90	23
365-001	ALAT POTONG KERAMIK 3 IN 1 400 MM	24
365-002	ALAT POTONG KERAMIK HEAVY DUTY 600 MM	24
365-003	ALAT POTONG KERAMIK 3 IN 1 600 MM	24
365-004	ALAT POTONG KERAMIK LASER 1000 MM	24

ITEM NO.		PAGE
362-041	ALAT POTONG PIPA TEMBAGA	80
373-110	ALAT POTONG RANTAI SEPEDA MOTOR	18
373-111	ALAT POTONG RANTAI SERBAGUNA	18
378-220	ALAT PRESS NEPEL SELANG	154
360-001	ALAT SODOK LEM 9"	25
360-002	ALAT SODOK LEM NYLON 9"	25
360-003	ALAT SODOK LEM PROFESIONAL 9"	25
360-004	ALAT SODOK LEM TABUNG ALUMUNIUM 9"	25
360-005	ALAT SODOK LEM TABUNG ALUMUNIUM 15"	25
362-007	ALAT STRAPING BAN PLASTIK	133
373-113	ALAT TUBLES BAN GAGANG BESI 7 PCS	07
373-114	ALAT TUBLES BAN 8 PCS	07
371-210	ALAT UKIR 16 PCS	23
369-100	AMPLAS BULAT 4" #16	28
369-101	AMPLAS BULAT 4" #24	28
369-102	AMPLAS BULAT 4" #36	28
369-104	AMPLAS BULAT 4" #60	28
369-105	AMPLAS BULAT 4" #80	28
369-106	AMPLAS BULAT 4" #100	28
369-107	AMPLAS BULAT 4" #120	28
369-108	AMPLAS BULAT 4" #150	28
369-151	AMPLAS BULAT VELCRO 4" #36	29
369-152	AMPLAS BULAT VELCRO 4" #60	29
369-153	AMPLAS BULAT VELCRO 4" #80	29
369-154	AMPLAS BULAT VELCRO 4" #100	29
369-155	AMPLAS BULAT VELCRO 4" #120	29
369-156	AMPLAS BULAT VELCRO 4" #150	29
369-157	AMPLAS BULAT VELCRO 4" #180	29
369-158	AMPLAS BULAT VELCRO 4" #240	29
369-091	AMPLAS KAIN WATERPROOF # 0	27
369-092	AMPLAS KAIN WATERPROOF # 1	27
369-093	AMPLAS KAIN WATERPROOF # 1.5	27
369-094	AMPLAS KAIN WATERPROOF # 2	27
369-095	AMPLAS KAIN WATERPROOF # 2.5	27
369-096	AMPLAS KAIN WATERPROOF # 3	27
369-111	AMPLAS KERTAS # 100	27
369-112	AMPLAS KERTAS # 120	27
369-113	AMPLAS KERTAS # 150	27
369-114	AMPLAS KERTAS # 180	27
369-115	AMPLAS KERTAS # 220	27
369-116	AMPLAS KERTAS # 240	27
369-117	AMPLAS KERTAS # 280	27
369-118	AMPLAS KERTAS # 320	27
369-119	AMPLAS KERTAS # 360	27
369-120	AMPLAS KERTAS # 400	27
369-121	AMPLAS KERTAS # 500	27
369-122	AMPLAS KERTAS # 600	27
369-123	AMPLAS KERTAS # 800	27
369-124	AMPLAS KERTAS # 1000	27
369-131	AMPLAS ROL 4" X 40 M #40	28
369-133	AMPLAS ROL 4" X 40 M #60	28
369-134	AMPLAS ROL 4" X 40 M #80	28
369-135	AMPLAS ROL 4" X 40 M #100	28
369-136	AMPLAS ROL 4" X 40 M #120	28
369-137	AMPLAS ROL 4" X 40 M #150	28
369-138	AMPLAS ROL 4" X 40 M #180	28
369-139	AMPLAS ROL 4" X 40 M #220	28
369-140	AMPLAS ROL 4" X 40 M #240	28
369-142	AMPLAS ROL 2" X 50 M #80	28
369-143	AMPLAS ROL 2" X 50 M #100	28
369-144	AMPLAS ROL 2" X 50 M #120	28
369-145	AMPLAS ROL 2" X 50 M #150	28
369-146	AMPLAS ROL 2" X 50 M #180	28

ITEM NO.		PAGE
369-147	AMPLAS ROL 2" X 50 M #220	28
369-148	AMPLAS ROL 2" X 50 M #240	28
371-101	AUGER BIT 5/16" X 200 MM	57
371-102	AUGER BIT 5/16" X 300 MM	57
371-103	AUGER BIT 3/8" X 200 MM	57
371-104	AUGER BIT 3/8" X 300 MM	57
371-105	AUGER BIT 1/2" X 200 MM	57
371-106	AUGER BIT 1/2" X 300 MM	57
371-107	AUGER BIT 5/8" X 200 MM	57
371-108	AUGER BIT 5/8" X 300 MM	57
371-109	AUGER BIT 2 FUNGSI 3/8 X 400 MM	57
371-110	AUGER BIT 2 FUNGSI 1/2 X 400 MM	57
371-111	AUGER BIT 2 FUNGSI 5/8 X 400 MM	57
371-112	AUGER BIT 2 FUNGSI 3/4 X 400 MM	57
397-001	AVOMETER YX-360-TRD	165
397-002	AVOMETER SP-15-D	165
B		
378-201	BALL VALVE PVC POLOS 1/2"	142
378-202	BALL VALVE PVC POLOS 3/4"	142
378-203	BALL VALVE PVC POLOS 1"	142
378-204	BALL VALVE PVC DRAT 1/2"	142
378-205	BALL VALVE PVC DRAT 3/4"	142
378-206	BALL VALVE PVC DRAT 1"	142
373-503	BANTALAN PLASTIK POLES + VELCRO 100 MM	17
373-507	BANTALAN PLASTIK POLES + VELCRO 125 MM	17
373-504	BANTALAN PLASTIK POLES + VELCRO 180 MM	17
369-003	BATU ASAH PISAU KETAM	30
369-013	BATU GOSOK ABU-ABU 6"	30
369-014	BATU GOSOK ABU-ABU 8"	30
369-016	BATU GURINDA 4" X 6 X 16 MM	140
369-027	BATU GURINDA ABU-ABU 6" X 1 X 1 & 1 1/4 - A60	141
369-037	BATU GURINDA ABU-ABU 12" X 1 1/2 X 1 1/4 - A46	141
369-039	BATU GURINDA HIJAU 6" X 1 X 1 & 1 1/4 - GC80	141
369-040	BATU GURINDA HIJAU 6" X 1 X 1 & 1 1/4 - GC100	141
369-001	BATU OSCO 5 PCS	30
369-002	BATU OSCO 10 PCS	30
369-005	BATU POTONG 4" X 1,2 MM	140
369-006	BATU POTONG 4" X 2 MM	140
369-008	BATU POTONG 14" X 3,2 MM	140
349-001	BETEL BESI MODEL PAYUNG 8"	31
349-002	BETEL BESI MODEL PAYUNG 10"	31
349-003	BETEL BESI MODEL PAYUNG 12"	31
C		
387-201	CARGO HOOK ALLOY STEEL 0.5 TON	147
387-202	CARGO HOOK ALLOY STEEL 0.75 TON	147
387-203	CARGO HOOK ALLOY STEEL 1.0 TON	147
387-204	CARGO HOOK ALLOY STEEL 2.0 TON	147
387-205	CARGO HOOK ALLOY STEEL 3.0 TON	147
387-206	CARGO HOOK ALLOY STEEL 5.0 TON	147
387-207	CARGO HOOK ALLOY STEEL 10.0 TON	147
356-101	CATOK C HEAVY DUTY 4"	134
356-102	CATOK C HEAVY DUTY 5"	134
356-103	CATOK C HEAVY DUTY 6"	134
356-104	CATOK C HEAVY DUTY 8"	134
356-105	CATOK C HEAVY DUTY 10"	134
356-106	CATOK C HEAVY DUTY 12"	134
356-021	CATOK F HEAVY DUTY 100 X 300 MM	134
356-022	CATOK F HEAVY DUTY 120 X 400 MM	134
356-023	CATOK F HEAVY DUTY 120 X 500 MM	134
356-024	CATOK F HEAVY DUTY 120 X 600 MM	134
356-025	CATOK F HEAVY DUTY 120 X 800 MM	134
356-026	CATOK F HEAVY DUTY 120 X 1000 MM	134
356-027	CATOK F HEAVY DUTY 120 X 1200 MM	134

ITEM NO.		PAGE
356-071	CATOK MEJA	135
356-011	CATOK PARON 3"/5,5 KG	135
356-012	CATOK PARON 4"/9,5 KG	135
356-013	CATOK PARON 5"/15 KG	135
356-014	CATOK PARON 6"/23 KG	135
356-015	CATOK PARON 8"/37 KG	135
356-083	CATOK PIPA NO: 2 (10 - 90 MM)	135
356-084	CATOK PIPA NO: 3 (15 - 115 MM)	135
356-085	CATOK PIPA NO: 4 (15 - 165 MM)	135
D		
366-202	DIAMOND CUP WHEEL 75 MM	59
366-201	DIAMOND CUP WHEEL 100 MM	59
366-013	DIAMOND GRINDING WHEEL DOUBLE 4"	59
366-014	DIAMOND GRINDING WHEEL DOUBLE 5"	59
366-011	DIAMOND WHEEL BASAH 4"	63
366-012	DIAMOND WHEEL KERING 4"	63
366-015	DIAMOND WHEEL SUPER THIN	63
366-111	DIAMOND WHEEL TURBO 4"	63
350-023	DRIP CENTER KHROM	31
387-001	DONGKRAK BOTOL 2 TON	11
387-002	DONGKRAK BOTOL 4 TON	11
387-003	DONGKRAK BOTOL 6 TON	11
387-004	DONGKRAK BOTOL 10 TON	11
387-005	DONGKRAK BOTOL 16 TON	11
387-006	DONGKRAK BOTOL 20 TON	11
387-007	DONGKRAK BOTOL 30 TON	11
387-008	DONGKRAK BOTOL 50 TON	11
387-010	DONGKRAK BUAYA 2 TON	11
387-017	DONGKRAK BUAYA HEAVY DUTY 3 TON	11
E		
387-231	ELECTRIC CHAIN HOIST 1T X 6 M	149
387-232	ELECTRIC CHAIN HOIST 2T X 6 M	149
387-233	ELECTRIC CHAIN HOIST 3T X 6 M	149
387-234	ELECTRIC CHAIN HOIST 1T X 12 M	149
387-236	ELECTRIC CHAIN HOIST 3T X 12 M	149
387-221	ELECTRIC HOIST 0.5 T X 930 W	148
387-222	ELECTRIC HOIST 1.0 T X 1.700 W	148
351-218	ENGSEL NYLON BEARING SS 3" X 2,5" X 2,0 MM	31
351-219	ENGSEL NYLON BEARING SS 4" X 3,0" X 2,3 MM	31
351-220	ENGSEL NYLON BEARING SS 5" X 3,0" X 2,3 MM	31
351-214	ENGSEL VER SS 3"	31
351-215	ENGSEL VER SS 4"	31
351-216	ENGSEL VER SS 5"	31
351-217	ENGSEL VER SS 6"	31
346-304	EXTENSION BAR SATIN CR-V 1/2" X 75 MM	103
346-305	EXTENSION BAR SATIN CR-V 1/2" X 125 MM	103
346-306	EXTENSION BAR SATIN CR-V 1/2" X 250 MM	103
F		
369-193	FLAP DISC 4" # 60	29
369-194	FLAP DISC 4" # 80	29
369-195	FLAP DISC 4" # 100	29
369-196	FLAP DISC 4" # 120	29
367-106	FULLER BLADE 13 PCS	12
G		
387-052	GANJALAN DONGKRAK 3 TON	11
387-053	GANJALAN DONGKRAK 6 TON	11
387-251	GEAR TROLLEY 1T X 3 M	149
387-252	GEAR TROLLEY 2T X 3 M	149
387-253	GEAR TROLLEY 3T X 3 M	149
387-254	GEAR TROLLEY 5T X 3 M	149
381-031	GEMBOK PANJANG HITAM 40 MM	143
381-032	GEMBOK PANJANG HITAM 50 MM	143
381-033	GEMBOK PANJANG HITAM 60 MM	143

ITEM NO.	PAGE	ITEM NO.	PAGE		
381-021	GEMBOK PENDEK HITAM 40 MM	143	399-017	HAND TAP 3 PCS 8 MM X 1,25	72
381-022	GEMBOK PENDEK HITAM 50 MM	143	399-018	HAND TAP 3 PCS 10 MM X 1,0	72
381-023	GEMBOK PENDEK HITAM 60 MM	143	399-019	HAND TAP 3 PCS 10 MM X 1,25	72
381-061	GEMBOK SEGITIGA PANJANG 3 PCS 40 MM	144	399-020	HAND TAP 3 PCS 10 MM X 1,5	72
381-062	GEMBOK SEGITIGA PANJANG 3 PCS 50 MM	144	399-021	HAND TAP 3 PCS 12 MM X 1,25	72
381-063	GEMBOK SEGITIGA PANJANG 3 PCS 60 MM	144	399-022	HAND TAP 3 PCS 12 MM X 1,5	72
381-051	GEMBOK SEGITIGA PANJANG 40 MM	144	399-023	HAND TAP 3 PCS 12 MM X 1,75	72
381-052	GEMBOK SEGITIGA PANJANG 50 MM	144	399-024	HAND TAP 3 PCS 14 MM X 1,25	72
381-053	GEMBOK SEGITIGA PANJANG 60 MM	144	399-025	HAND TAP 3 PCS 14 MM X 1,5	72
381-066	GEMBOK SEGITIGA PENDEK 3 PCS 40 MM	144	399-026	HAND TAP 3 PCS 14 MM X 2,0	72
381-067	GEMBOK SEGITIGA PENDEK 3 PCS 50 MM	144	399-027	HAND TAP 3 PCS 16 MM X 1,25	72
381-068	GEMBOK SEGITIGA PENDEK 3 PCS 60 MM	144	399-028	HAND TAP 3 PCS 16 MM X 1,5	72
381-056	GEMBOK SEGITIGA PENDEK 40 MM	144	399-029	HAND TAP 3 PCS 16 MM X 2,0	72
381-057	GEMBOK SEGITIGA PENDEK 50 MM	144	399-051	HAND TAP 3 PCS 1/8" X 40	72
381-058	GEMBOK SEGITIGA PENDEK 60 MM	144	399-052	HAND TAP 3 PCS 3/16" X 24	72
363-003	GERGAJI 5 IN 1	32	399-053	HAND TAP 3 PCS 1/4" X 20	72
363-041	GERGAJI BUSUR 3 IN 1	32	399-054	HAND TAP 3 PCS 5/16" X 18	72
363-004	GERGAJI DAHAN GAGANG ORANGE	74	399-055	HAND TAP 3 PCS 3/8" X 16	72
363-011	GERGAJI GOROK 2 SECTION 18"	33	399-056	HAND TAP 3 PCS 1/2" X 12	72
363-012	GERGAJI GOROK 2 SECTION 20"	33	399-057	HAND TAP 3 PCS 5/8" X 11	72
363-030	GERGAJI GOROK 3 SECTION 2 PCS 18" & 20"	33	386-401	HIDROMETER AIR AKI	13
363-031	GERGAJI GOROK GAGANG KARET 3 SECTION 18"	33	371-131	HOLE CUTTER BESI HSS 16 MM	66
363-032	GERGAJI GOROK GAGANG KARET 3 SECTION 20"	33	371-132	HOLE CUTTER BESI HSS 19 MM	66
363-021	GERGAJI GOROK GAGANG KAYU 3 SECTION 18"	33	371-133	HOLE CUTTER BESI HSS 20 MM	66
363-022	GERGAJI GOROK GAGANG KAYU 3 SECTION 20"	33	371-134	HOLE CUTTER BESI HSS 22 MM	66
363-033	GERGAJI GYPSUM 150 MM	54	371-135	HOLE CUTTER BESI HSS 24 MM	66
363-005	GERGAJI SUDUT 2 SECTION	32	371-136	HOLE CUTTER BESI HSS 25 MM	66
363-001	GERGAJI TANGKAI MODEL LIPAT	74	371-137	HOLE CUTTER BESI HSS 28 MM	66
360-006	GLUE GUN 10 W	164	371-138	HOLE CUTTER BESI HSS 30 MM	66
360-007	GLUE GUN 40 W	164	371-139	HOLE CUTTER BESI HSS 32 MM	66
360-008	GLUE GUN 60 W	164	371-140	HOLE CUTTER BESI HSS 40 MM	66
360-009	GLUE GUN 80 W	164	371-141	HOLE CUTTER BESI HSS 42 MM	66
360-021	GLUE STICK 100 X 7,2M	164	371-142	HOLE CUTTER BESI HSS 50 MM	66
360-022	GLUE STICK 250 X 11,2M	164	371-126	HOLE SAW BESI 13 PCS	66
359-011	GREASE GUN HITAM	08	371-125	HOLE SAW KAYU 11 PCS	58
359-012	GREASE GUN MERAH	08	371-121	HOLE SAW SET 7 BLADE 25 MM	58
359-010	GREASE GUN MINI	08	371-122	HOLE SAW SET 7 BLADE 50 MM	58
362-001	GUNTING BETON 18"	34	387-266	HORIZONTAL LIFTING CLAMP 0.75 T	150
362-002	GUNTING BETON 24"	34	387-267	HORIZONTAL LIFTING CLAMP 1.5 T	150
362-003	GUNTING BETON 30"	34	387-268	HORIZONTAL LIFTING CLAMP 2.0 T	150
362-004	GUNTING BETON 36"	34			
362-005	GUNTING BETON 42"	34			
362-021	GUNTING SENG 8"	34	358-013	ISI STAPLES ANGIN F-10	136
362-022	GUNTING SENG 10"	34	358-014	ISI STAPLES ANGIN F-15	136
362-024	GUNTING SS GAGANG KUNING HITAM	158	358-015	ISI STAPLES ANGIN F-20	136
362-025	GUNTING KAIN SS 8,5"	158	358-016	ISI STAPLES ANGIN F-25	136
362-026	GUNTING SS GAGANG PVC 7"	158	358-017	ISI STAPLES ANGIN F-30	136
362-027	GUNTING SERBAGUNA	158	358-011	ISI STAPLES MODEL SQUARE 6 MM	136
362-028	GUNTING DAPUR 8,5"	159	358-012	ISI STAPLES MODEL SQUARE 8 MM	136
362-033	GUNTING DAHAN GAGANG KAYU	73	358-033	ISI STAPLES MODEL SQUARE 10 MM	136
362-036	GUNTING DAHAN TYPE JAPAN	73	358-034	ISI STAPLES MODEL SQUARE 12 MM	136
362-090	GUNTING KABEL 10"	132	358-035	ISI STAPLES MODEL SQUARE 14 MM	136
362-100	GUNTING 6,5"	159	358-043	ISI STAPLES MODEL T 10 MM	136
362-102	GUNTING SS 250 MM	159	358-044	ISI STAPLES MODEL T 12 MM	136
362-112	GUNTING SENG & GALVALUM MODEL LURUS	34	358-045	ISI STAPLES MODEL T 14 MM	136
362-151	GUNTING RUMPUT 3 POSISI	74	358-060	ISI STAPLES ANGIN 1006 J	136
	H		358-061	ISI STAPLES ANGIN 1008 J	136
399-011	HAND TAP 3 PCS 3 MM X 0,5	72	358-062	ISI STAPLES ANGIN 1010 J	136
399-012	HAND TAP 3 PCS 4 MM X 0,7	72	358-063	ISI STAPLES ANGIN 1013 J	136
399-013	HAND TAP 3 PCS 5 MM X 0,8	72	358-070	ISI STAPLES ANGIN 406 J	136
399-014	HAND TAP 3 PCS 6 MM X 1,0	72	358-071	ISI STAPLES ANGIN 408 J	136
399-015	HAND TAP 3 PCS 7 MM X 1,0	72	358-072	ISI STAPLES ANGIN 410 J	136
399-016	HAND TAP 3 PCS 8 MM X 1,0	72	358-073	ISI STAPLES ANGIN 413 J	136

ITEM NO.		PAGE
J		
344-005	JAS HUJAN & CELANA SCOTLIGHT XL	173
344-004	JAS HUJAN HIJAU M	173
K		
386-022	KABEL AKI 200 A X 2,5 M	13
386-023	KABEL AKI 300 A X 2,5 M	13
386-011	KABEL TIE 30 M	162
386-012	KABEL TIE 50 M	162
386-014	KABEL TIE 100 M	162
386-031	KABEL TIE 5 WARNA 2,5X100MM(200PCS)	162
386-032	KABEL TIE 5 WARNA 2,5X150MM(250PCS)	162
386-033	KABEL TIE 5 WARNA 3,5X200MM(100PCS)	162
386-034	KABEL TIE 5 WARNA 4,5X250MM(50PCS)	162
386-035	KABEL TIE PUTIH 2,5 X 100 MM	162
386-061	KABEL TIE PUTIH 2,5 X 150 MM	162
386-062	KABEL TIE PUTIH 3,5 X 200 MM	162
386-063	KABEL TIE PUTIH 4,5 X 250 MM	162
386-064	KABEL TIE PUTIH 4,5 X 300 MM	162
386-065	KABEL TIE MERAH 2,5 X 100 MM	163
386-066	KABEL TIE MERAH 2,5 X 150 MM	163
386-067	KABEL TIE MERAH 3,5 X 200 MM	163
386-068	KABEL TIE MERAH 4,5 X 250 MM	163
386-069	KABEL TIE MERAH 4,5 X 300 MM	163
386-070	KABEL TIE KUNING 2,5 X 100 MM	163
386-071	KABEL TIE KUNING 2,5 X 150 MM	163
386-072	KABEL TIE KUNING 3,5 X 200 MM	163
386-073	KABEL TIE KUNING 4,5 X 250 MM	163
386-074	KABEL TIE KUNING 4,5 X 300 MM	163
386-075	KABEL TIE HIJAU 2,5 X 100 MM	163
386-076	KABEL TIE HIJAU 2,5 X 150 MM	163
386-077	KABEL TIE HIJAU 3,5 X 200 MM	163
386-078	KABEL TIE HIJAU 4,5 X 250 MM	163
386-079	KABEL TIE HIJAU 4,5 X 300 MM	163
386-080	KABEL TIE HITAM 2,5 X 100 MM	163
386-081	KABEL TIE HITAM 2,5 X 150 MM	163
386-082	KABEL TIE HITAM 3,5 X 200 MM	163
386-083	KABEL TIE HITAM 4,5 X 250 MM	163
386-084	KABEL TIE HITAM 4,5 X 300 MM	163
383-081	KACAMATA SAFETY ANTI KABUT	174
383-078	KACAMATA SAFETY GB 014-1	175
383-076	KACAMATA SAFETY GB 028	175
383-077	KACAMATA SAFETY GB 048	175
383-074	KACAMATA SAFETY TRANSPARAN GB 010	174
383-041	KACAMATA SELAM	179
373-031	KAIN LAP PEMBERSIH SERBAGUNA	15
377-036	KAPI CAT 1.5"	35
377-037	KAPI CAT 2"	35
377-038	KAPI CAT 2.5"	35
377-039	KAPI CAT 3"	35
377-040	KAPI CAT 4"	35
377-031	KAPI CAT MIRROR POLISH	35
377-042	KAPI CAT STAINLESS GG KARET 1,5"	35
377-043	KAPI CAT STAINLESS GG KARET 2"	35
377-044	KAPI CAT STAINLESS GG KARET 2,5"	35
377-045	KAPI CAT STAINLESS GG KARET 3"	35
377-046	KAPI CAT STAINLESS GG KARET 4"	35
345-401	KAPUR BESI	36
387-095	KATROL BESI OPEN 3" X 0.5 TON	147
387-096	KATROL BESI OPEN 4" X 1.0 TON	147
387-097	KATROL BESI OPEN 5" X 2.0 TON	147
387-098	KATROL BESI OPEN 6" X 3.2 TON	147
387-099	KATROL BESI OPEN 8" X 5.0 TON	147
387-102	KATROL HEAVY DUTY 1 T X 3 M	148

ITEM NO.		PAGE
387-104	KATROL HEAVY DUTY 2 T X 3 M	148
387-105	KATROL HEAVY DUTY 3 T X 3 M	148
387-106	KATROL HEAVY DUTY 5 T X 3 M	148
387-112	KATROL HEAVY DUTY 1 T X 5 M	148
387-114	KATROL HEAVY DUTY 2 T X 5 M	148
387-115	KATROL HEAVY DUTY 3 T X 5 M	148
387-116	KATROL HEAVY DUTY 5 T X 5 M	148
387-117	KATROL HEAVY DUTY 10 T X 5 M	148
387-210	KATROL HEAVY DUTY 2 T X 10 M	148
387-211	KATROL HEAVY DUTY 3 T X 10 M	148
387-212	KATROL HEAVY DUTY 5 T X 10 M	148
387-213	KATROL HEAVY DUTY 10 T X 10 M	148
385-182	KEPALA TRIMMER LINE	62
393-004	KETOK ANGKA 4 MM	154
393-005	KETOK ANGKA 5 MM	154
393-009	KETOK ANGKA 12 MM	154
393-103	KETOK HURUF 3 MM	154
393-104	KETOK HURUF 4 MM	154
393-108	KETOK HURUF 10 MM	154
352-001	KIKIR EMAS SET 10 PCS	81
352-002	KIKIR SET 7 PCS	81
352-003	KIKIR CHAINSAW 8" X 5,5 MM	81
352-004	KIKIR CHAINSAW 8" X 4,8 MM	81
352-006	KIKIR PLAT KASAR 8"	82
352-007	KIKIR PLAT KASAR 10"	82
352-008	KIKIR PLAT KASAR 12"	82
352-012	KIKIR SEGITIGA 3"	82
352-013	KIKIR SEGITIGA 4"	82
352-014	KIKIR SEGITIGA 5"	82
352-015	KIKIR SEGITIGA 6"	82
352-026	KIKIR SETENGAH BULAT KASAR 8"	82
352-027	KIKIR SETENGAH BULAT KASAR 10"	82
352-036	KIKIR BULAT KASAR 8"	82
352-037	KIKIR BULAT KASAR 10"	82
352-038	KIKIR DIAMOND 6 PCS	83
352-039	KIKIR DIAMOND 5 PCS	83
352-046	KIKIR KAYU SETENGAH BULAT 8"	83
352-047	KIKIR KAYU SETENGAH BULAT 10"	83
352-048	KIKIR KAYU SETENGAH BULAT 12"	83
398-021	KLEM SELANG STAINLESS TUAS NYLON 5/8"	170
398-022	KLEM SELANG STAINLESS TUAS NYLON 3/4"	170
398-023	KLEM SELANG STAINLESS TUAS NYLON 7/8"	170
398-024	KLEM SELANG STAINLESS TUAS NYLON 1"	170
398-025	KLEM SELANG STAINLESS TUAS NYLON 1 1/4"	170
398-026	KLEM SELANG STAINLESS TUAS NYLON 1 1/2"	170
362-044	KOP KACA 3 KAKI	36
378-303	KRAN AIR BALING KHROM 1/2"	37
378-304	KRAN AIR FLAT KHROM 1/2"	37
373-401	KRAN KOMPRESOR KUNINGAN 1/4"	137
378-301	KRAN TAMAN PVC BALING PUTIH 1/2"	36
378-302	KRAN TAMAN PVC FLAT PUTIH 1/2"	36
378-305	KRAN WASTAFEL BALING KHROM 1/2"	37
377-011	KUAS CAT BULU HITAM 1"	38
377-012	KUAS CAT BULU HITAM 1.5"	38
377-013	KUAS CAT BULU HITAM 2"	38
377-014	KUAS CAT BULU HITAM 2.5"	38
377-015	KUAS CAT BULU HITAM 3"	38
377-016	KUAS CAT BULU HITAM 4"	38
377-017	KUAS CAT BULU HITAM 5"	38
377-001	KUAS CAT BULU PUTIH 1"	38
377-002	KUAS CAT BULU PUTIH 1.5"	38
377-003	KUAS CAT BULU PUTIH 2"	38
377-004	KUAS CAT BULU PUTIH 2.5"	38

ITEM NO.	PAGE	ITEM NO.	PAGE		
377-005	KUAS CAT BULU PUTIH 3"	38	346-513	KUNCI PAS CR-V HITAM 20 X 22 MM	93
377-006	KUAS CAT BULU PUTIH 4"	38	346-515	KUNCI PAS CR-V HITAM 24 X 27 MM	93
377-007	KUAS CAT BULU PUTIH 5"	38	346-516	KUNCI PAS CR-V HITAM 25 X 28 MM	93
377-081	KUAS CAT GG PLASTIK BULU PUTIH 1"	38	346-517	KUNCI PAS CR-V HITAM 30 X 32 MM	93
377-082	KUAS CAT GG PLASTIK BULU PUTIH 1.5"	38	346-722	KUNCI PAS KHROM 8 X 9 MM	94
377-083	KUAS CAT GG PLASTIK BULU PUTIH 2"	38	346-723	KUNCI PAS KHROM 8 X 10 MM	94
377-084	KUAS CAT GG PLASTIK BULU PUTIH 2.5"	38	346-724	KUNCI PAS KHROM 10 X 11 MM	94
377-020	KUAS CAT POLYESTER 1"	38	346-725	KUNCI PAS KHROM 10 X 12 MM	94
377-021	KUAS CAT POLYESTER 1.5"	38	346-726	KUNCI PAS KHROM 12 X 13 MM	94
377-022	KUAS CAT POLYESTER 2"	38	346-727	KUNCI PAS KHROM 12 X 14 MM	94
377-023	KUAS CAT POLYESTER 2.5"	38	346-728	KUNCI PAS KHROM 14 X 15 MM	94
377-024	KUAS CAT POLYESTER 3"	38	346-729	KUNCI PAS KHROM 14 X 17 MM	94
377-025	KUAS CAT POLYESTER 4"	38	346-730	KUNCI PAS KHROM 16 X 17 MM	94
377-009	KUAS ROL 9"	39	346-731	KUNCI PAS KHROM 17 X 19 MM	94
377-010	KUAS ROL KAPAL 4"	39	346-732	KUNCI PAS KHROM 18 X 19 MM	94
346-206	KUNCI BACO KHROM 10"	84	346-733	KUNCI PAS KHROM 20 X 22 MM	94
346-207	KUNCI BACO KHROM 12"	84	346-734	KUNCI PAS KHROM 21 X 23 MM	94
346-208	KUNCI BACO KHROM 15"	84	346-735	KUNCI PAS KHROM 24 X 27 MM	94
346-160	KUNCI BACO KHROM 18"	84	346-736	KUNCI PAS KHROM 25 X 28 MM	94
346-162	KUNCI BACO SATIN 8"	84	346-737	KUNCI PAS KHROM 30 X 32 MM	94
346-163	KUNCI BACO SATIN 10"	84	346-738	KUNCI PAS KHROM SET 8 PCS (6 - 24 MM)	94
346-164	KUNCI BACO SATIN 12"	84	346-739	KUNCI PAS KHROM SET 12 PCS (6 - 32 MM)	94
346-165	KUNCI BACO SATIN 15"	84	346-008	KUNCI PAS SATIN CR-V 14 X 15 MM	90
346-274	KUNCI BACO SATIN GG KUNING HITAM 8"	84	346-010	KUNCI PAS SATIN CR-V 16 X 17 MM	90
346-196	KUNCI BUSI FLEKSIBEL 16 MM	104	346-012	KUNCI PAS SATIN CR-V 18 X 19 MM	90
346-197	KUNCI BUSI FLEKSIBEL 21 MM	104	346-013	KUNCI PAS SATIN CR-V 20 X 22 MM	90
353-200	KUNCI DISGRINDER	133	346-014	KUNCI PAS SATIN CR-V 21 X 23 MM	90
346-480	KUNCI DOUBLE RATCHET CR-V HITAM 10 X 12 MM	85	346-015	KUNCI PAS SATIN CR-V 24 X 27 MM	90
346-481	KUNCI DOUBLE RATCHET CR-V HITAM 11 X 13 MM	85	346-016	KUNCI PAS SATIN CR-V 25 X 28 MM	90
346-482	KUNCI DOUBLE RATCHET CR-V HITAM 12 X 14 MM	85	346-017	KUNCI PAS SATIN CR-V 30 X 32 MM	90
346-483	KUNCI DOUBLE RATCHET CR-V HITAM 14 X 17 MM	85	346-072	KUNCI PAS SATIN CR-V SET 8 PCS (6 - 22 MM)	90
346-586	KUNCI KLEP SEPEDA MOTOR MODEL L	18	346-073	KUNCI PAS SATIN CR-V SET 12 PCS (6 - 32 MM)	90
346-173	KUNCI L BALLPOINT 9 PCS 1.5-10 MM	86	346-740	KUNCI PAS SERBAGUNA 2 PCS	99
346-176	KUNCI L BALLPOINT EXTRA LONG 9 PCS 1.5-10MM	86	346-251	KUNCI PIPA 10"	85
346-187	KUNCI L BINTANG LONG 9 PCS T10-T50	87	346-252	KUNCI PIPA 12"	85
346-171	KUNCI L CR-V 10 PCS 1.5-10 MM	86	346-253	KUNCI PIPA 14"	85
346-172	KUNCI L CR-V 10 PCS 1/16-3/8"	86	346-254	KUNCI PIPA 18"	85
346-178	KUNCI L CR-V 5 PCS X 6 MM	88	346-255	KUNCI PIPA 24"	85
346-157	KUNCI L CR-V BINTANG T45	88	346-256	KUNCI PIPA 36"	85
346-158	KUNCI L CR-V BINTANG T50	88	346-091	KUNCI RING BINTANG SATIN CR-V 4 PCS	98
346-231	KUNCI L GAGANG T CR-V T 2,5	89	346-076	KUNCI RING BULAN SATIN CR-V 10 X 12 MM	98
346-232	KUNCI L GAGANG T CR-V T 3	89	346-077	KUNCI RING BULAN SATIN CR-V 11 X 13 MM	98
346-235	KUNCI L GAGANG T CR-V T 6	89	346-078	KUNCI RING BULAN SATIN CR-V 14 X 17 MM	98
346-236	KUNCI L GAGANG T CR-V T 8	89	346-079	KUNCI RING BULAN SATIN CR-V 16 X 18 MM	98
346-237	KUNCI L GAGANG T CR-V T 10	89	346-533	KUNCI RING CR-V HITAM 20 X 22 MM	93
346-182	KUNCI L HITAM 10 PCS	87	346-534	KUNCI RING CR-V HITAM 21 X 23 MM	93
346-321	KUNCI L KOMBINASI SATIN 9 PCS	87	346-535	KUNCI RING CR-V HITAM 24 X 27 MM	93
346-175	KUNCI L LIPAT BINTANG 8 PCS T9-T40	86	346-536	KUNCI RING CR-V HITAM 25 X 28 MM	93
346-330	KUNCI L SATIN KHROM CR-V 1,5 MM	89	346-537	KUNCI RING CR-V HITAM 30 X 32 MM	93
346-331	KUNCI L SATIN KHROM CR-V 2 MM	89	346-771	KUNCI RING KHROM 6 X 7 MM	95
346-332	KUNCI L SATIN KHROM CR-V 2,5 MM	89	346-772	KUNCI RING KHROM 8 X 9 MM	95
346-333	KUNCI L SATIN KHROM CR-V 3 MM	89	346-773	KUNCI RING KHROM 8 X 10 MM	95
346-334	KUNCI L SATIN KHROM CR-V 4 MM	89	346-774	KUNCI RING KHROM 10 X 11 MM	95
346-335	KUNCI L SATIN KHROM CR-V 5 MM	89	346-775	KUNCI RING KHROM 10 X 12 MM	95
346-336	KUNCI L SATIN KHROM CR-V 6 MM	89	346-776	KUNCI RING KHROM 12 X 13 MM	95
346-337	KUNCI L SATIN KHROM CR-V 8 MM	89	346-777	KUNCI RING KHROM 12 X 14 MM	95
346-338	KUNCI L SATIN KHROM CR-V 10 MM	89	346-778	KUNCI RING KHROM 14 X 15 MM	95
346-339	KUNCI L SATIN KHROM CR-V 12 MM	89	346-779	KUNCI RING KHROM 14 X 17 MM	95
346-340	KUNCI L SATIN KHROM CR-V 14 MM	89	346-780	KUNCI RING KHROM 16 X 17 MM	95
346-713	KUNCI NEPEL 12 X 14 MM	91	346-781	KUNCI RING KHROM 17 X 19 MM	95
346-191	KUNCI OLI FILTER 3 KAKI	12	346-782	KUNCI RING KHROM 18 X 19 MM	95
346-192	KUNCI OLI FILTER KULIT 9"	12	346-783	KUNCI RING KHROM 20 X 22 MM	95
346-195	KUNCI OLI FILTER RANTAI 9"	12	346-784	KUNCI RING KHROM 21 X 23 MM	95

INDEX

SORT BY ALPHABETICAL

ITEM NO.	PAGE	ITEM NO.	PAGE
346-785	95	346-628	92
346-786	95	346-629	92
346-787	95	346-630	92
346-789	95	346-631	92
346-790	95	346-632	92
346-549	93	346-633	92
346-553	93	346-634	92
346-554	93	346-635	92
346-555	93	346-028	91
346-564	93	346-030	91
346-742	96	346-036	91
346-743	96	346-037	91
346-744	96	346-201	106
346-745	96	346-212	105
346-746	96	346-213	105
346-747	96	346-211	105
346-748	96	346-214	106
346-749	96	346-229	169
346-750	96	346-452	102
346-751	96	346-453	102
346-752	96	346-454	102
346-753	96	346-455	102
346-754	96	346-456	102
346-755	96	346-457	102
346-756	96	346-458	102
346-758	96	346-459	102
346-759	96	346-460	102
346-760	96	346-461	102
346-761	96	346-462	102
346-762	96	346-463	102
346-763	96	346-464	102
346-764	96	346-465	102
346-765	96	346-466	102
346-766	96	346-467	102
346-791	96	346-468	102
346-792	96	346-469	102
346-793	96	346-470	102
346-794	96	346-471	102
346-767	97	346-660	102
346-768	97	346-661	102
346-769	97	346-662	102
346-643	98	346-663	102
346-644	98	346-664	102
346-041	92	346-665	102
346-042	92	346-666	102
346-044	92	346-667	102
346-049	92	346-668	102
346-053	92	346-669	102
346-054	92	346-670	102
346-055	92	346-671	102
346-600	92	346-672	102
346-601	92	346-673	102
346-602	92	346-674	102
346-605	92	346-675	102
346-606	92	346-676	102
346-607	92	346-677	102
346-621	92	346-678	102
346-622	92	346-679	102
346-623	92	346-404	104
346-624	92	346-405	104
346-625	92	346-198	104
346-626	92	346-199	104
346-627	92	346-841	100

ITEM NO.	PAGE	ITEM NO.	PAGE		
346-842	KUNCI SOK IMPACT ADAPTOR CR-MO 3/4" F X 1/2"	100	346-147	KUNCI SOK T ROTARI 10 MM	108
346-843	KUNCI SOK IMPACT ADAPTOR CR-MO 3/4" F X 1"	100	346-149	KUNCI SOK T ROTARI 14 MM	108
346-801	KUNCI SOK IMPACT HITAM 22 MM X 3/4" DR	100	346-150	KUNCI SOK T ROTARI 17 MM	108
346-802	KUNCI SOK IMPACT HITAM 23 MM X 3/4" DR	100	346-151	KUNCI SOK Y HITAM LONG 8 X 9 X 10 MM	109
346-805	KUNCI SOK IMPACT HITAM 28 MM X 3/4" DR	100	346-152	KUNCI SOK Y HITAM LONG 8 X 10 X 12 MM	109
346-808	KUNCI SOK IMPACT HITAM 33 MM X 3/4" DR	100	346-153	KUNCI SOK Y HITAM LONG 10 X 11 X 13 MM	109
346-809	KUNCI SOK IMPACT HITAM 34 MM X 3/4" DR	100	346-154	KUNCI SOK Y HITAM LONG 10 X 12 X 14 MM	109
346-810	KUNCI SOK IMPACT HITAM 35 MM X 3/4" DR	100	346-155	KUNCI SOK Y HITAM LONG 12 X 14 X 17 MM	109
346-812	KUNCI SOK IMPACT HITAM 38 MM X 3/4" DR	100	L		
346-813	KUNCI SOK IMPACT HITAM 41 MM X 3/4" DR	100	360-111	LAKBAN TALANG	26
346-814	KUNCI SOK IMPACT HITAM 42 MM X 3/4" DR	100	392-001	LAMPU KERJA	13
346-815	KUNCI SOK IMPACT HITAM 45 MM X 3/4" DR	100	344-022	LAMPU PELAMPUNG AIR	179
346-817	KUNCI SOK IMPACT HITAM 48 MM X 3/4" DR	100	392-004	LAMPU SENTER KEPALA 5 W	167
346-818	KUNCI SOK IMPACT HITAM 50 MM X 3/4" DR	100	392-003	LAMPU SENTER KEPALA LED 8 PCS	167
346-821	KUNCI SOK IMPACT HITAM 22 MM X 1" DR	100	392-002	LAMPU SOROT LED 13 PCS	167
346-822	KUNCI SOK IMPACT HITAM 23 MM X 1" DR	100	360-101	LEM SILICONE TABUNG NETRAL BENING	26
346-823	KUNCI SOK IMPACT HITAM 24 MM X 1" DR	100	360-102	LEM SILICONE TABUNG NETRAL HITAM	26
346-825	KUNCI SOK IMPACT HITAM 28 MM X 1" DR	100	360-103	LEM SILICONE TABUNG NETRAL PUTIH	26
346-826	KUNCI SOK IMPACT HITAM 30 MM X 1" DR	100	360-104	LEM SILICONE TABUNG NETRAL ABU - ABU	26
346-829	KUNCI SOK IMPACT HITAM 34 MM X 1" DR	100	387-303	LEVER BLOCK 1.5 T X 1.5 M	148
346-830	KUNCI SOK IMPACT HITAM 35 MM X 1" DR	100	387-304	LEVER BLOCK 3.0 T X 1.5 M	148
346-831	KUNCI SOK IMPACT HITAM 36 MM X 1" DR	100	M		
346-832	KUNCI SOK IMPACT HITAM 38 MM X 1" DR	100	348-173	MAGNETIC SOCKET 4 PCS	23
346-834	KUNCI SOK IMPACT HITAM 42 MM X 1" DR	100	374-003	MANOMETER 2 1/2" X 10 KG	137
346-835	KUNCI SOK IMPACT HITAM 45 MM X 1" DR	100	374-004	MANOMETER 2 1/2" X 16 KG	137
346-836	KUNCI SOK IMPACT HITAM 46 MM X 1" DR	100	374-005	MANOMETER 2 1/2" X 20 KG	137
346-837	KUNCI SOK IMPACT HITAM 48 MM X 1" DR	100	374-006	MANOMETER 2 1/2" X 25 KG	137
346-838	KUNCI SOK IMPACT HITAM 50 MM X 1" DR	100	374-008	MANOMETER 2 1/2" X 200 KG	137
346-100	KUNCI SOK MODEL L 17 MM	106	383-003	MASKER KUNING PVC	176
346-101	KUNCI SOK MODEL L 19 MM	106	371-001	MATA BEADING BIT TCT 1/4" X 5/32"	60
346-103	KUNCI SOK MODEL L 23 MM	106	371-002	MATA BEADING BIT TCT 1/4" X 3/16"	60
346-140	KUNCI SOK ROTARI 8 IN 1	99	371-003	MATA BEADING BIT TCT 1/4" X 1/4"	60
346-401	KUNCI SOK SET 9 PCS	101	371-004	MATA BEADING BIT TCT 1/4" X 5/16"	60
346-402	KUNCI SOK SET 10 PCS	101	353-301	MATA BOR BESI CO8 - FOR STAINLESS 1 MM	68
346-403	KUNCI SOK SET 25 PCS	101	353-302	MATA BOR BESI CO8 - FOR STAINLESS 1.5 MM	68
346-106	KUNCI SOK T 3 IN 1 8 X 9 X 10 MM	107	353-303	MATA BOR BESI CO8 - FOR STAINLESS 2 MM	68
346-107	KUNCI SOK T 3 IN 1 8 X 10 X 12 MM	107	353-304	MATA BOR BESI CO8 - FOR STAINLESS 2.5 MM	68
346-108	KUNCI SOK T 3 IN 1 10 X 11 X 13 MM	107	353-305	MATA BOR BESI CO8 - FOR STAINLESS 3 MM	68
346-109	KUNCI SOK T 3 IN 1 10 X 12 X 14 MM	107	353-307	MATA BOR BESI CO8 - FOR STAINLESS 3,5 MM	68
346-110	KUNCI SOK T 3 IN 1 12 X 14 X 17 MM	107	353-308	MATA BOR BESI CO8 - FOR STAINLESS 4 MM	68
346-113	KUNCI SOK T CR-V HANDLE KARET HITAM 11 MM	107	353-309	MATA BOR BESI CO8 - FOR STAINLESS 4,5 MM	68
346-115	KUNCI SOK T CR-V HANDLE KARET HITAM 13 MM	107	353-311	MATA BOR BESI CO8 - FOR STAINLESS 5 MM	68
346-124	KUNCI SOK T SLIDING 12 MM	107	353-312	MATA BOR BESI CO8 - FOR STAINLESS 5,5 MM	68
346-126	KUNCI SOK T SLIDING 14 MM	107	353-313	MATA BOR BESI CO8 - FOR STAINLESS 6 MM	68
346-127	KUNCI SOK T SLIDING 17 MM	107	353-314	MATA BOR BESI CO8 - FOR STAINLESS 6,5 MM	68
346-131	KUNCI SOK T CR-V HITAM 8 MM	107	353-315	MATA BOR BESI CO8 - FOR STAINLESS 7 MM	68
346-132	KUNCI SOK T CR-V HITAM 10 MM	107	353-316	MATA BOR BESI CO8 - FOR STAINLESS 7,5 MM	68
346-133	KUNCI SOK T CR-V HITAM 11 MM	107	353-317	MATA BOR BESI CO8 - FOR STAINLESS 8 MM	68
346-134	KUNCI SOK T CR-V HITAM 12 MM	107	353-318	MATA BOR BESI CO8 - FOR STAINLESS 8,5 MM	68
346-135	KUNCI SOK T CR-V HITAM 13 MM	107	353-319	MATA BOR BESI CO8 - FOR STAINLESS 9 MM	68
346-136	KUNCI SOK T CR-V HITAM 14 MM	107	353-320	MATA BOR BESI CO8 - FOR STAINLESS 9,5 MM	68
346-137	KUNCI SOK T CR-V HITAM 17 MM	107	353-321	MATA BOR BESI CO8 - FOR STAINLESS 10 MM	68
346-282	KUNCI SOK T GAGANG KARET 11 MM	108	353-322	MATA BOR BESI CO8 - FOR STAINLESS 10,5 MM	68
346-283	KUNCI SOK T GAGANG KARET 12 MM	108	353-323	MATA BOR BESI CO8 - FOR STAINLESS 11 MM	68
346-284	KUNCI SOK T GAGANG KARET 13 MM	108	353-324	MATA BOR BESI CO8 - FOR STAINLESS 11,5 MM	68
346-285	KUNCI SOK T GAGANG KARET 14 MM	108	353-325	MATA BOR BESI CO8 - FOR STAINLESS 12 MM	68
346-287	KUNCI SOK T GAGANG KARET 19 MM	108	353-326	MATA BOR BESI CO8 - FOR STAINLESS 12,5 MM	68
346-141	KUNCI SOK Y KHROM 8 X 9 X 10 MM	109	353-327	MATA BOR BESI CO8 - FOR STAINLESS 13 MM	68
346-142	KUNCI SOK Y KHROM 8 X 10 X 12 MM	109	353-351	MATA BOR BESI H.S.S KHROM 1,0 MM	69
346-143	KUNCI SOK Y KHROM 10 X 11 X 13 MM	109	353-352	MATA BOR BESI H.S.S KHROM 1,5 MM	69
346-144	KUNCI SOK Y KHROM 10 X 12 X 14 MM	109	353-353	MATA BOR BESI H.S.S KHROM 2,0 MM	69
346-145	KUNCI SOK Y KHROM 12 X 14 X 17 MM	109	353-354	MATA BOR BESI H.S.S KHROM 2,5 MM	69
346-146	KUNCI SOK T ROTARI 8 MM	108	353-355	MATA BOR BESI H.S.S KHROM 3,0 MM	69

ITEM NO.	PAGE	ITEM NO.	PAGE
353-357	69	MATA BOR KONES JIS 14 MM	67
353-358	69	MATA BOR KONES JIS 15 MM	67
353-359	69	MATA BOR KONES JIS 15.5 MM	67
353-361	69	MATA BOR KONES JIS 16 MM	67
353-362	69	MATA BOR KONES JIS 16.5 MM	67
353-363	69	MATA BOR KONES JIS 17.5 MM	67
353-364	69	MATA BOR KONES JIS 18.5 MM	67
353-365	69	MATA BOR KONES JIS 19 MM	67
353-366	69	MATA BOR KONES JIS 19.5 MM	67
353-367	69	MATA BOR KONES JIS 20 MM	67
353-368	69	MATA BOR KONES JIS 20.5 MM	67
353-369	69	MATA BOR KONES JIS 21 MM	67
353-370	69	MATA BOR KONES JIS 21.5 MM	67
353-371	69	MATA BOR KONES JIS 22.5 MM	67
353-372	69	MATA BOR KONES JIS 23 MM	67
353-373	69	MATA BOR KONES JIS 23.5 MM	67
353-374	69	MATA BOR KONES JIS 24 MM	67
353-375	69	MATA BOR KONES JIS 24.5 MM	67
353-376	69	MATA BOR KONES JIS 25 MM	67
353-377	69	MATA BOR KONES JIS 25.5 MM	67
353-378	69	MATA BOR KONES JIS 26 MM	67
353-011	64	MATA BOR KONES JIS 26.5 MM	67
353-012	64	MATA BOR KONES JIS 27 MM	67
353-013	64	MATA BOR KONES JIS 27.5 MM	67
353-014	64	MATA BOR KONES JIS 28 MM	67
353-015	64	MATA BOR KONES JIS 28.5 MM	67
353-017	64	MATA BOR KONES JIS 29 MM	67
353-019	64	MATA BOR KONES JIS 29.5 MM	67
353-020	64	MATA BOR KONES JIS 30 MM	67
353-030	64	MATA BOR MULTIFUNGSI 4-12 MM	66
353-031	64	MATA BOR MULTIFUNGSI 4-20 MM	66
353-032	64	MATA BOR MULTIFUNGSI 4-32 MM	66
353-033	64	MATA BOR ROTARI TCT 10 PCS SHANK 3 MM	70
353-034	64	MATA BOR ROTARI TCT 10 PCS SHANK 6 MM	70
353-035	64	MATA BOR SET HSS 13 PCS (1,5-6,5MM)	69
353-094	64	MATA BOR SET HSS 19 PCS (1-10MM)	69
353-090	64	MATA BOR SET HSS 25 PCS (1-13 MM)	69
353-043	57	MATA BOR UNCEK 4 PCS	59
353-044	57	MATA CLASSICAL COVE BIT TCT 1/4" X 3/16"	60
353-045	57	MATA CLASSICAL COVE BIT TCT 1/4" X 1/4"	60
353-340	57	MATA CLASSICAL COVE BIT TCT 1/4" X 5/16"	60
353-341	57	MATA CLASSICAL OGEE BIT TCT 1/4" X 3/16"	61
353-342	57	MATA CLASSICAL OGEE BIT TCT 1/4" X 1/4"	61
353-343	57	MATA CLASSICAL OGEE BIT TCT 1/4" X 5/16"	61
353-005	58	MT CLASSICAL ROMAN OGEE BIT TCT 1/4" X 3/16"	61
353-250	65	MT CLASSICAL ROMAN OGEE BIT TCT 1/4" X 1/4"	61
353-251	65	MT CLASSICAL ROMAN OGEE BIT TCT 1/4" X 5/16"	61
353-252	65	MATA COVE BIT TCT 1/4" X 3/16"	61
353-253	65	MATA COVE BIT TCT 1/4" X 1/4"	61
353-254	65	MATA COVE BIT TCT 1/4" X 5/16"	61
353-255	65	MATA GERGAJI BESI ENGKEL 12"X 24 T	70
353-256	65	MATA GERGAJI MESIN 14" X 10 T	70
353-257	65	MATA GERGAJI MESIN 16" X 10 T	70
353-258	65	MATA GERINDA AMPLAS CAT 100 MM	27
353-259	65	MATA GERINDA POLES NON WOVEN 100 MM	29
353-260	65	MATA GERINDA POLES WOOL 4" X 10 MM	29
353-261	65	MATA OBENG ANGIN 10 PCS 65 MM X PH 2	118
353-262	65	MATA OBENG ANGIN 10 PCS 65 MM X SLOT 6	118
353-263	65	MATA OBENG KETOK 6 PCS PH 2 X 80 MM	117
353-264	65	MATA OBENG KETOK 6 PCS PH 3 X 80 MM	117
353-265	65	MT OBENG KETOK S2 BROWN 10 PCS PH 2X80MM	117
353-266	65	MT OBENG KETOK S2 BROWN 10 PCS PH 3X80MM	117
353-267	65	MATA POTONG BETON 20 MM	48

ITEM NO.	PAGE	ITEM NO.	PAGE		
362-071	MATA POTONG BETON 28 MM	48	348-046	OBENG ELEKTRONIK CR-V 5" X 3 MM (-)	112
362-072	MATA POTONG BETON 32 MM	48	348-047	OBENG ELEKTRONIK CR-V 6" X 3 MM (+)	112
365-101	MATA POTONG KERAMIK 3 IN 1	24	348-048	OBENG ELEKTRONIK CR-V 6" X 3 MM (-)	112
365-102	MATA POTONG KERAMIK HEAVY DUTY 600 MM	24	348-049	OBENG ELEKTRONIK CR-V 8" X 3 MM (+)	112
371-053	MATA ROMAN OGEE BIT TCT 1/4" X 1/4"	61	348-050	OBENG ELEKTRONIK CR-V 8" X 3 MM (-)	112
371-052	MATA ROMAN OGEE BIT TCT 1/4" X 3/16"	61	348-541	OBENG ELEKTRONIK CR-V 3" X 3 MM (+)	112
371-054	MATA ROMAN OGEE BIT TCT 1/4" X 5/16"	61	348-542	OBENG ELEKTRONIK CR-V 3" X 3 MM (-)	112
371-011	MATA SLOTTING BIT TCT 1/4" X 3 MM	60	348-543	OBENG ELEKTRONIK CR-V 4" X 3 MM (+)	112
371-012	MATA SLOTTING BIT TCT 1/4" X 4 MM	60	348-544	OBENG ELEKTRONIK CR-V 4" X 3 MM (-)	112
371-013	MATA SLOTTING BIT TCT 1/4" X 5 MM	60	348-141	OBENG GAGANG KARET CR-V 4" X 6 MM (+)	112
371-014	MATA SLOTTING BIT TCT 1/4" X 6 MM	60	348-142	OBENG GAGANG KARET CR-V 4" X 6 MM (-)	112
371-015	MATA SLOTTING BIT TCT 1/4" X 8 MM	60	348-143	OBENG GAGANG KARET CR-V 5" X 6 MM (+)	112
371-021	MATA STRAIGHT BIT TCT 1/4" X 3 MM	60	348-144	OBENG GAGANG KARET CR-V 5" X 6 MM (-)	112
371-022	MATA STRAIGHT BIT TCT 1/4" X 4 MM	60	348-145	OBENG GAGANG KARET CR-V 6" X 6 MM (+)	112
371-023	MATA STRAIGHT BIT TCT 1/4" X 5 MM	60	348-146	OBENG GAGANG KARET CR-V 6" X 6 MM (-)	112
371-024	MATA STRAIGHT BIT TCT 1/4" X 6 MM	60	348-106	OBENG HANDPHONE 4 PCS	116
371-025	MATA STRAIGHT BIT TCT 1/4" X 8 MM	60	391-022	OBENG KACAMATA 12 IN 1 13 PCS	115
368-001	METERAN FIBER 30 M	40	348-161	OBENG KETOK 5 PCS	117
368-002	METERAN FIBER 50 M	40	348-163	OBENG KETOK 12 PCS	117
368-003	METERAN FIBER 100 M	40	348-101	OBENG LISTRIK 5 PCS	114
368-041	METERAN JALAN	41	348-192	OBENG RATCHET BOLAK BALIK	113
368-027	METERAN ROL BODI KARET 5 M X 19 MM	40	348-191	OBENG RATCHET MODEL T BOLAK BALIK	113
368-028	METERAN ROL BODI KARET 7,5 M X 25 MM	40	348-213	OBENG S2.15 IN 1	116
368-022	METERAN ROL KUNING 5 M X 19 MM	40	348-109	OBENG T ROTARI PH 2	113
368-023	METERAN ROL KUNING 7,5 M X 25 MM	40	348-015	OBENG TEMBUS 7 PCS	110
367-051	MIKROMETER 0 - 25 MM	120	348-130	OBENG TEMBUS CR-V GAGANG BIRU 3" X 5MM (+)	110
367-052	MIKROMETER 25 - 50 MM	120	348-131	OBENG TEMBUS CR-V GAGANG BIRU 3" X 5MM (-)	110
367-053	MIKROMETER 50 - 75 MM	120	348-132	OBENG TEMBUS CR-V GAGANG BIRU 4" X 6MM (+)	110
367-054	MIKROMETER 75 - 100 MM	120	348-133	OBENG TEMBUS CR-V GAGANG BIRU 4" X 6MM (-)	110
366-101	MULTICUTTER 4" X 40 T	59	348-134	OBENG TEMBUS CR-V GAGANG BIRU 5" X 6MM (+)	110
397-003	MULTITESTER DIGITAL	165	348-135	OBENG TEMBUS CR-V GAGANG BIRU 5" X 6MM (-)	110
	N		348-136	OBENG TEMBUS CR-V GAGANG BIRU 6" X 6MM (+)	110
378-041	NEPEL KING BSPT SEGI ENAM 1/2"	143	348-137	OBENG TEMBUS CR-V GAGANG BIRU 6" X 6MM (-)	110
378-042	NEPEL KING BSPT SEGI ENAM 3/4"	143	348-138	OBENG TEMBUS CR-V GAGANG BIRU 8" X 6MM (+)	110
378-043	NEPEL KING BSPT SEGI ENAM 1"	143	348-139	OBENG TEMBUS CR-V GAGANG BIRU 8" X 6MM (-)	110
378-044	NEPEL KING BSPT SEGI ENAM 1 1/4"	143	348-001	OBENG TEMBUS GG TRANSPARAN 3" X 5 MM (-)	110
378-045	NEPEL KING BSPT SEGI ENAM 1 1/2"	143	348-002	OBENG TEMBUS GG TRANSPARAN 3" X 5 MM (+)	110
378-046	NEPEL KING BSPT SEGI ENAM 2"	143	348-003	OBENG TEMBUS GG TRANSPARAN 4" X 6 MM (-)	110
378-047	NEPEL KING BSPT 2 1/2"	143	348-004	OBENG TEMBUS GG TRANSPARAN 4" X 6 MM (+)	110
378-048	NEPEL KING BSPT 3"	143	348-005	OBENG TEMBUS GG TRANSPARAN 5" X 6 MM (-)	110
378-049	NEPEL KING BSPT 4"	143	348-006	OBENG TEMBUS GG TRANSPARAN 5" X 6 MM (+)	110
378-050	NEPEL KING BSPT 6"	143	348-007	OBENG TEMBUS GG TRANSPARAN 6" X 6 MM (-)	110
378-051	NEPEL KING BSPT 8"	143	348-008	OBENG TEMBUS GG TRANSPARAN 6" X 6 MM (+)	110
373-002	NEPEL PENGISI ANGIN MODEL BULAT	02	348-009	OBENG TEMBUS GG TRANSPARAN 8" X 8 MM (-)	110
373-003	NEPEL PENGISI ANGIN MODEL JEPIT	02	348-010	OBENG TEMBUS GG TRANSPARAN 8" X 8 MM (+)	110
	O		348-011	OBENG TEMBUS GG TRANSPARAN 10" X 8 MM (-)	110
348-121	OBENG ARLOJI 6 PCS	115	348-012	OBENG TEMBUS GG TRANSPARAN 10" X 8 MM (+)	110
348-122	OBENG ARLOJI CR-V 6 PCS	115	348-111	OBENG TESPEN 7"	114
348-083	OBENG CEBOL 2 PCS	111	348-115	OBENG TESPEN TEGANGAN DC	114
348-081	OBENG CEBOL CR-V 1,5" x 6 MM (+)	111	348-116	OBENG FARADIC TESTER 5,5"	114
348-082	OBENG CEBOL CR-V 1,5" x 6 MM (-)	111	359-031	OIL SUCTION GUN 500 CC	09
348-021	OBENG COLORLINE CR-V 3" X 6 MM (+)	112	359-032	OIL CAN TABUNG TRANSPARAN 350 CC	09
348-022	OBENG COLORLINE CR-V 3" X 6 MM (-)	112	359-033	OIL CAN TABUNG BESI 200 CC	09
348-023	OBENG COLORLINE CR-V 4" X 6 MM (+)	112	359-034	OIL CAN TABUNG BESI 300 CC	09
348-024	OBENG COLORLINE CR-V 4" X 6 MM (-)	112	390-016	O-RING SET 407 PCS 3 MM - 50 MM	16
348-025	OBENG COLORLINE CR-V 5" X 6 MM (+)	112	390-017	O-RING SET 407 PCS 1/8" - 2"	16
348-026	OBENG COLORLINE CR-V 5" X 6 MM (-)	112	390-018	O-RING SET 225 PCS 3 MM - 22 MM	16
348-027	OBENG COLORLINE CR-V 6" X 6 MM (+)	112	390-019	O-RING SET 225 PCS 3/32" - 3/4"	16
348-028	OBENG COLORLINE CR-V 6" X 6 MM (-)	112		P	
348-029	OBENG COLORLINE CR-V 8" X 6 MM (+)	112	351-001	PAKU BETON GALVANIS 3 X 1"	48
348-030	OBENG COLORLINE CR-V 8" X 6 MM (-)	112	351-002	PAKU BETON GALVANIS 3 X 1 1/4"	48
348-215	OBENG CR-V 10 IN 1	116	351-003	PAKU BETON GALVANIS 3 X 1 1/2"	48
348-045	OBENG ELEKTRONIK CR-V 5" X 3 MM (+)	112	351-004	PAKU BETON GALVANIS 3,6 X 2"	48

ITEM NO.		PAGE	ITEM NO.		PAGE
351-005	PAKU BETON GALVANIS 4 X 2 1/2"	48	354-146	PALU KUNINGAN GAGANG PVC 10 LB X 820 MM	43
351-006	PAKU BETON GALVANIS 4,2 X 3"	48	354-151	PALU TEMBAGA GAGANG PVC 2 LB X 280 MM	44
351-007	PAKU BETON GALVANIS 4,5 X 4"	48	354-152	PALU TEMBAGA GAGANG PVC 3 LB X 300 MM	44
351-010	PAKU BETON HITAM 25 X 2 MM	48	354-153	PALU TEMBAGA GAGANG PVC 4 LB X 320 MM	44
351-011	PAKU BETON HITAM 40 X 3 MM	48	354-154	PALU TEMBAGA GAGANG PVC 6 LB X 620 MM	44
351-012	PAKU BETON HITAM 50 X 3 MM	48	354-155	PALU TEMBAGA GAGANG PVC 8 LB X 820 MM	44
351-013	PAKU BETON HITAM 60 X 3 MM	48	354-156	PALU TEMBAGA GAGANG PVC 10 LB X 820 MM	44
351-014	PAKU BETON HITAM 75 x 4,2 MM	48	354-071	PALU TUKANG 140 G	46
351-015	PAKU BETON HITAM 100 x 4,2 MM	48	354-072	PALU TUKANG 210 G	46
354-121	PALU BATU 2 LB X 400 GRAM	43	354-073	PALU TUKANG 240 G	46
354-122	PALU BATU 3 LB X 400 GRAM	43	378-192	PELAMPUNG AIR 2,5 KG	179
354-123	PALU BATU 4 LB X 400 GRAM	43	368-210	PENGGARIS BENANG + KAPUR + WATERPASS	49
354-124	PALU BATU 6 LB X 400 GRAM	43	362-073	PISAU BUBUT 1/4 X 4"	70
354-125	PALU BATU 8 LB X 400 GRAM	43	362-074	PISAU BUBUT 5/16 X 4"	70
354-126	PALU BATU 10 LB X 400 GRAM	43	362-075	PISAU BUBUT 3/8 X 4"	70
354-127	PALU BATU 12 LB X 400 GRAM	43	362-076	PISAU BUBUT 1/2 X 4"	70
354-128	PALU BATU 14 LB X 400 GRAM	43	362-077	PISAU BUBUT 5/8 X 4"	70
354-129	PALU BATU 16 LB X 400 GRAM	43	362-083	PISAU BUBUT 1/4 X 6"	70
354-130	PALU BATU 18 LB X 400 GRAM	43	362-084	PISAU BUBUT 5/16 X 6"	70
354-131	PALU BATU 20 LB X 400 GRAM	43	362-085	PISAU BUBUT 3/8 X 6"	70
354-001	PALU BATU GAGANG FIBER 2 LB X 30 CM	43	362-086	PISAU BUBUT 1/2 X 6"	70
354-002	PALU BATU GAGANG FIBER 3 LB X 35 CM	43	362-087	PISAU BUBUT 5/8 X 6"	70
354-003	PALU BATU GAGANG FIBER 4 LB X 40 CM	43	362-061	PISAU CUTTER 5 BLADE	160
354-004	PALU BATU GAGANG FIBER 6 LB X 90 CM	43	362-062	PISAU CUTTER 2 PCS	160
354-005	PALU BATU GAGANG FIBER 8 LB X 90 CM	43	362-056	PISAU CUTTER 3 BLADE	160
354-006	PALU BATU GAGANG FIBER 10 LB X 90 CM	43	362-065	PISAU LIPAT 12 IN 1	161
354-007	PALU BATU GAGANG FIBER 12 LB X 90 CM	43	362-060	PISAU LIPAT 5 BLADE	160
354-008	PALU BATU GAGANG FIBER 14 LB X 90 CM	43	362-055	PISAU PEMOTONG SERBAGUNA	159
354-101	PALU FINIL 1.0 LB	44	362-141	PISAU POTONG RUMPUT	62
354-102	PALU FINIL 1.5 LB	44	362-142	PISAU POTONG RUMPUT BULAT	62
354-103	PALU FINIL 2.0 LB	44	362-059	PISAU SADAP KARET	79
354-021	PALU KAMBING GAGANG FIBER 8 OZ	45	390-011	PISTON RING NO. 3 (5"X 75MM)	18
354-022	PALU KAMBING GAGANG FIBER 13 OZ	45	390-012	PISTON RING NO. 4 (7"X100MM)	18
354-023	PALU KAMBING GAGANG FIBER 16 OZ	45	390-013	PISTON RING NO. 7 (50-150 MM)	18
354-031	PALU KAMBING GAGANG KAYU 8 OZ	45	387-242	PLAIN TROLLEY 2 T	150
354-033	PALU KAMBING GAGANG KAYU 16 OZ	45	387-243	PLAIN TROLLEY 3 T	150
354-084	PALU KAMBING MINI 8 OZ	46	387-244	PLAIN TROLLEY 5 T	150
354-083	PALU KAMBING MIRROR POLISHED 16 OZ	45	362-201	PLONG KULIT SET 5 PCS	119
354-034	PALU KAMBING PIPA BESI 8 OZ	45	362-202	PLONG KULIT SET 12 PCS	119
354-035	PALU KAMBING PIPA BESI 13 OZ	45	394-026	POLICELINE 2"X300M (HITAM KUNING)	177
354-036	PALU KAMBING PIPA BESI 16 OZ	45	394-028	POLICELINE 2"X300M (PUTIH MERAH)	177
354-051	PALU KARET GAGANG FIBER 8 OZ	44	394-027	POLICELINE 3"X300M (HITAM KUNING)	177
354-052	PALU KARET GAGANG FIBER 12 OZ	44	394-029	POLICELINE 3"X300M (PUTIH MERAH)	177
354-053	PALU KARET GAGANG FIBER 16 OZ	44	376-011	POMPA CLOSET KARET HL 5018	157
354-054	PALU KARET GAGANG FIBER 24 OZ	44	376-012	POMPA CLOSET KARET HL 5017	157
354-063	PALU KETOK KARAT 300 G	47	376-004	POMPA INJAK	168
354-065	PALU KETOK KARAT 500 G	47	359-041	POMPA OLI	10
354-066	PALU KETOK LAS 300 G	47	359-043	POMPA OLI PVC	10
354-011	PALU KONDE GAGANG FIBER 8 OZ	46	376-003	POMPA TABUNG ALUMINIUM + METER	168
354-012	PALU KONDE GAGANG FIBER 12 OZ	46	376-008	POMPA TABUNG HITAM + METER	168
354-013	PALU KONDE GAGANG FIBER 16 OZ	46	R		
354-014	PALU KONDE GAGANG FIBER 24 OZ	46	345-301	RANTAI PLASTIK 6 MM X 25 M (MERAH)	171
354-015	PALU KONDE GAGANG FIBER 32 OZ	46	345-302	RANTAI PLASTIK 8 MM X 25 M (MERAH)	171
354-041	PALU KONDE GAGANG KAYU 8 OZ	46	345-303	RANTAI PLASTIK 10 MM X 25 M (MERAH)	171
354-042	PALU KONDE GAGANG KAYU 12 OZ	46	345-304	RANTAI PLASTIK 12 MM X 25 M (MERAH)	171
354-043	PALU KONDE GAGANG KAYU 16 OZ	46	345-305	RANTAI PLASTIK 6 MM X 25 M (KUNING)	171
354-044	PALU KONDE GAGANG KAYU 24 OZ	46	345-306	RANTAI PLASTIK 8 MM X 25 M (KUNING)	171
354-045	PALU KONDE GAGANG KAYU 32 OZ	46	345-307	RANTAI PLASTIK 10 MM X 25 M (KUNING)	171
354-141	PALU KUNINGAN GAGANG PVC 2 LB X 280 MM	43	345-308	RANTAI PLASTIK 12 MM X 25 M (KUNING)	171
354-142	PALU KUNINGAN GAGANG PVC 3 LB X 300 MM	43	345-309	RANTAI PLASTIK 6 MM X 25 M (HITAM)	171
354-143	PALU KUNINGAN GAGANG PVC 4 LB X 320 MM	43	345-310	RANTAI PLASTIK 8 MM X 25 M (HITAM)	171
354-144	PALU KUNINGAN GAGANG PVC 6 LB X 610 MM	43	345-311	RANTAI PLASTIK 10 MM X 25 M (HITAM)	171
354-145	PALU KUNINGAN GAGANG PVC 8 LB X 820 MM	43	345-312	RANTAI PLASTIK 12 MM X 25 M (HITAM)	171

ITEM NO.	PAGE	ITEM NO.	PAGE	
395-001	RECOIL HOSE PU 6 M	137	359-100 SELANG GREASE GUN	08
395-002	RECOIL HOSE PU 9 M	137	378-101 SELANG MESIN CUCI	172
395-003	RECOIL HOSE PU 12 M	137	378-102 SELANG POMPA TABUNG KUNING	168
377-008	REFILL KUAS ROL 9"	39	378-014 SEMPROTAN AIR 2 IN 1	77
377-019	REFILL KUAS ROL KAPAL 4"	39	378-008 SEMPROTAN AIR 5 IN 1	76
362-666	REFILL PISAU CUTTER 10 PCS	161	378-009 SEMPROTAN AIR 7 POSISI (5 PCS)	76
373-115	REFILL TUBLES BAN 25 PCS 4" X 6 MM	07	378-004 SEMPROTAN AIR 7 POSISI	76
373-116	REFILL TUBLES BAN 25 PCS 8" X 6 MM	07	378-007 SEMPROTAN AIR GAGANG PANJANG	76
373-502	REFILL WOOL POLES + VELCRO 7"	17	378-001 SEMPROTAN AIR KEPALA KUNINGAN	75
373-500	REFILL WOOL POLES 5"	17	378-002 SEMPROTAN AIR KEPALA PVC	75
373-501	REFILL WOOL POLES 7"	17	378-006 SEMPROTAN AIR KUNINGAN	77
383-044	REGULATOR SELAM	179	378-015 SEMPROTAN AIR KUNINGAN BODY KARET	77
345-207	RODA DEPAN (KECIL) HAND PALLET 3"	151	378-003 SEMPROTAN AIR MODEL LURUS PLASTIK	75
351-224	RODA PAGAR BULAT 6 CM	151	378-038 SEMPROTAN AIR MODEL PISTOL	77
351-225	RODA PAGAR BULAT 7 CM	151	377-068 SENDOK SEMEN BULAT WARNA BIRU 6"	50
351-226	RODA PAGAR BULAT 8 CM	151	377-069 SENDOK SEMEN BULAT WARNA BIRU 7"	50
351-228	RODA PAGAR BULAT 10 CM	151	377-070 SENDOK SEMEN BULAT WARNA BIRU 8"	50
351-221	RODA PAGAR SIKU 6 CM	151	377-074 SENDOK SEMEN BULAT WARNA SILVER 6"	50
351-222	RODA PAGAR SIKU 7 CM	151	377-075 SENDOK SEMEN BULAT WARNA SILVER 7"	50
351-223	RODA PAGAR SIKU 8 CM	151	377-076 SENDOK SEMEN BULAT WARNA SILVER 8"	50
351-227	RODA PAGAR SIKU 10 CM	151	377-071 SENDOK SEMEN OVAL WARNA BIRU 6"	50
380-023	RODA PU HEAVY DUTY HIDUP 4"	152	377-072 SENDOK SEMEN OVAL WARNA BIRU 7"	50
380-024	RODA PU HEAVY DUTY HIDUP 5"	152	377-073 SENDOK SEMEN OVAL WARNA BIRU 8"	50
380-025	RODA PU HEAVY DUTY HIDUP 6"	152	377-077 SENDOK SEMEN OVAL WARNA SILVER 6"	50
380-026	RODA PU HEAVY DUTY MATI 4"	152	377-078 SENDOK SEMEN OVAL WARNA SILVER 7"	50
380-027	RODA PU HEAVY DUTY MATI 5"	152	377-079 SENDOK SEMEN OVAL WARNA SILVER 8"	50
380-028	RODA PU HEAVY DUTY MATI 6"	152	377-172 SENDOK SEMEN PERSEGI STAINLESS GERIGI	52
380-029	RODA PU HEAVY DUTY + REM 4"	153	377-171 SENDOK SEMEN PERSEGI STAINLESS RATA	52
380-030	RODA PU HEAVY DUTY + REM 5"	153	386-059 SENTER LED 10 W	167
380-031	RODA PU HEAVY DUTY + REM 6"	153	361-003 SIKAT BAJA GAGANG KUNING	53
380-032	RODA PVC MEDIUM HIDUP 3"	153	361-042 SIKAT BAJA GRENDA 3 PCS	139
380-033	RODA PVC MEDIUM HIDUP 4"	153	361-043 SIKAT BAJA GRENDA 5 PCS	139
380-034	RODA PVC MEDIUM HIDUP 5"	153	361-038 SIKAT BAJA GRENDA BULAT 38 MM	139
380-035	RODA PVC MEDIUM MATI 3"	153	361-039 SIKAT BAJA GRENDA BULAT 50 MM	139
380-036	RODA PVC MEDIUM MATI 4"	153	361-040 SIKAT BAJA GRENDA BULAT 63 MM	139
380-037	RODA PVC MEDIUM MATI 5"	153	361-041 SIKAT BAJA GRENDA BULAT 75 MM	139
380-021	RODA SCAFFOLDING 6"	152	361-035 SIKAT BAJA GRENDA MANGKOK 50 MM	139
380-022	RODA SCAFFOLDING 8"	152	361-036 SIKAT BAJA GRENDA MANGKOK 63 MM	139
S				
385-101	SABUK PENGAMAN	178	361-037 SIKAT BAJA GRENDA MANGKOK 75 MM	139
385-102	SABUK PENGAMAN FULL BODY	178	361-031 SIKAT BAJA GRENDA TANGKAI 12 X 27 MM	138
385-103	SABUK PENGAMAN FULL BODY HOOK BESAR	178	361-032 SIKAT BAJA GRENDA TANGKAI 19 X 27 MM	138
359-051	SARINGAN MINYAK PLASTIK 5,5"	169	361-033 SIKAT BAJA GRENDA TANGKAI 24 X 27 MM	138
359-052	SARINGAN MINYAK PLASTIK 6,5"	169	361-034 SIKAT BAJA GRENDA TANGKAI 28 X 28 MM	138
384-002	SARUNG TANGAN LAS KULIT BIRU 14"	180	361-001 SIKAT BAJA HITAM GAGANG PLASTIK	53
384-008	SARUNG TANGAN LAS KULIT BIRU 18"	180	361-020 SIKAT BAJA KUNING GAGANG PLASTIK	53
384-003	SARUNG TANGAN LAS KULIT KUNING 16"	180	361-022 SIKAT KOMBINASI 7"	53
384-001	SARUNG TANGAN LAS KULIT MERAH 14"	180	361-021 SIKAT KOMBINASI 9"	53
384-005	SARUNG TANGAN PVC BIRU	177	361-011 SIKAT MANGKOK 3" X M10 X 1,5 -SS	138
384-004	SARUNG TANGAN PVC COKLAT	177	361-012 SIKAT MANGKOK 4" X M14 X 2,0 -SS	138
394-010	SEAL TAPE 1/2" X 10 M X 0.075 MM	49	361-013 SIKAT MANGKOK 3" X M10 X 1,5 STEEL	138
394-011	SEAL TAPE 3/4" X 15 M X 0.2 MM	49	361-014 SIKAT MANGKOK 4" X M14 X 2,0 STEEL	138
394-013	SEAL TAPE 1 "X 15 M X 0.075 MM	49	361-015 SIKAT MANGKOK KEPANG 3" X M10 X 1,5	138
343-002	SEKOP PASIR GAGANG FIBER LANCIP	51	356-111 SIKU MAGNET MINI 4 PCS	134
343-001	SEKOP PASIR GAGANG FIBER PAPAN	51	356-112 SIKU MAGNET WELDING 3" (25LBS)	134
343-003	SEKOP SEPADAN GAGANG KAYU	51	356-113 SIKU MAGNET WELDING 4" (50LBS)	134
351-126	SEKRUP KAYU KUNINGAN 1 1/2" X 8 MM	155	356-114 SIKU MAGNET WELDING 5" (75LBS)	134
378-081	SELANG FLEKSIBEL AIR DINGIN 30 CM	172	377-231 SIKU RAK 4" X 5" X 0,8 MM	56
378-082	SELANG FLEKSIBEL AIR DINGIN 40 CM	172	377-232 SIKU RAK 5" X 6" X 0,8 MM	56
378-083	SELANG FLEKSIBEL AIR DINGIN 50 CM	172	377-233 SIKU RAK 6" X 8" X 0,8 MM	56
378-084	SELANG FLEKSIBEL AIR PANAS 30 CM	172	377-234 SIKU RAK 8" X 10" X 0,8 MM	56
378-085	SELANG FLEKSIBEL AIR PANAS 40 CM	172	377-235 SIKU RAK 10" X 12" X 1,0 MM	56
378-086	SELANG FLEKSIBEL AIR PANAS 50 CM	172	377-236 SIKU RAK 12" X 14" X 1,0 MM	56
			377-246 SIKU RAK PUTIH LIPAT 8"	56

ITEM NO.	PAGE	ITEM NO.	PAGE
377-247	56	385-173	171
377-248	56	345-210	14
377-249	56	385-080	14
377-241	56	385-081	14
377-242	56	385-082	14
377-243	56	385-083	14
377-244	56	385-104	178
377-222	41	385-231	145
377-223	41	385-232	145
367-001	120	385-233	145
367-002	120	385-234	145
367-006	120	385-235	145
367-007	120	385-236	145
367-003	120	385-237	145
346-309	99	385-238	145
346-303	103	385-239	145
360-011	166	385-240	145
360-012	166	385-241	145
360-013	166	385-242	145
360-014	166	385-243	145
360-019	166	385-244	145
360-017	166	385-245	145
360-016	166	385-211	145
377-102	05	385-212	145
377-103	06	385-213	145
377-105	06	385-214	145
377-106	06	385-215	145
377-101	05	385-216	145
377-104	06	385-217	145
377-111	05	385-218	145
372-011	10	385-219	145
373-041	17	385-220	145
373-040	17	385-221	145
378-025	79	385-222	145
378-026	79	385-223	145
378-027	79	385-224	145
373-304	133	347-099	123
356-122	135	347-033	127
356-124	135	347-040	127
378-021	78	347-032	127
378-029	78	347-031	127
378-022	78	347-077	130
364-001	54	347-078	130
364-004	55	347-094	130
364-010	55	347-095	130
364-002	54	347-026	126
364-003	54	347-004	123
346-302	103	347-007	124
346-308	103	347-008	124
399-007	72	347-009	124
399-008	72	347-000	125
399-009	72	347-001	122
358-002	121	347-002	122
358-021	121	347-003	122
358-001	121	347-068	131
358-007	01	347-067	131
358-005	01	347-066	122
378-222	142	347-071	126
378-223	142	347-012	124
360-114	26	347-016	125
T			
385-171	171	347-011	122
385-172	171	347-100	126
		347-201	133

ITEM NO.		PAGE
347-023	TANG POTONG ELEKTRIK 125 MM"	123
347-024	TANG POTONG ELEKTRIK 160 MM"	123
347-022	TANG POTONG KHROM 6"	124
347-006	TANG POTONG MINI 4.5"	125
347-300	TANG POTONG PIPA PVC 42 MM	130
347-021	TANG POTONG SATIN 6"	122
347-042	TANG RIVET BODI KHROM 10"	129
347-044	TANG RIVET FLEKSIBEL TIPE EROPA 11,5"	129
347-041	TANG RIVET BODI HITAM 9,5"	129
347-043	TANG RIVET TIPE JAPAN 10,5"	129
347-070	TANG SERBAGUNA 18 IN 1	161
347-401	TANG SIWARAN GERGAJI 175 MM	130
347-069	TANG SKUN KABEL SERBAGUNA 8"	132
347-046	TANG SLIP JOINT 6"	124
347-047	TANG SLIP JOINT 8"	124
347-051	TANG SNAP RING BENGKOK BUKA 7"	128
347-053	TANG SNAP RING BENGKOK TUTUP 7"	128
347-052	TANG SNAP RING LURUS BUKA 7"	128
347-054	TANG SNAP RING LURUS TUTUP 7"	128
347-065	TANG TERMINAL KOMPUTER	131
347-112	TANG TERMINAL SKUN KABEL 7,5"	132
399-004	TAP & DIE SET 20 PCS	71
399-003	TAP & DIE SET 40 PCS	71
399-002	TAP BALIK 6 PCS	71
399-061	TAP BALIK KRAN AIR	71
371-241	TATAH KAYU GG PLASTIK 5/16"	55
371-242	TATAH KAYU GG PLASTIK 3/8"	55
371-243	TATAH KAYU GG PLASTIK 1/2"	55
371-244	TATAH KAYU GG PLASTIK 5/8"	55
371-245	TATAH KAYU GG PLASTIK 3/4"	55
371-246	TATAH KAYU GG PLASTIK 1"	55
371-247	TATAH KAYU GG PLASTIK 1 1/4"	55
371-248	TATAH KAYU GG PLASTIK 1 1/2"	55
359-042	TEST PUMP	10
367-090	TIMBANGAN GANTUNG 25 KG	169
367-091	TIMBANGAN GANTUNG 50 KG	169
367-092	TIMBANGAN GANTUNG 100 KG	169
367-101	TIMBANGAN KUE + PIRINGAN STAINLESS 5 KG	169
367-102	TIMBANGAN KUE + PIRINGAN STAINLESS 10 KG	169
367-103	TIMBANGAN KUE + PIRINGAN STAINLESS 15 KG	169
367-104	TIMBANGAN KUE + PIRINGAN STAINLESS 20 KG	169
345-190	TONGKAT LAMPU LALU LINTAS	13
391-005	TOOL BOX 2 SUSUN KUNING 15"	19
391-006	TOOL BOX 2 SUSUN KUNING 20"	19
391-019	TOOL BOX PLASTIK 12"	19
391-018	TOOL BOX PLASTIK 15"	19
391-023	TOOL SET 100 PCS	19
383-053	TOPENG PELINDUNG TRANSPARAN MDL PUTAR	174
357-007	TREKER 2 FUNGSI 4"	20
357-008	TREKER 2 FUNGSI 6"	20
357-009	TREKER 2 FUNGSI 8"	20
357-001	TREKER 3 KAKI 3"	20
357-002	TREKER 3 KAKI 4"	20
357-003	TREKER 3 KAKI 6"	20
357-004	TREKER 3 KAKI 8"	20
357-005	TREKER 3 KAKI 10"	20
357-006	TREKER 3 KAKI 12"	20
357-031	TREKER BALL JOINT	21
390-001	TREKER BEARING AB-1	20
390-002	TREKER BEARING AB-2	20
357-014	TREKER MAGNIT HONDA TIGER	21
357-019	TREKER MAGNIT UNIVERSAL HONDA NEOTEX	22
357-020	TREKER MAGNIT UNIVERSAL YAMAHA FORCE-1	22

ITEM NO.		PAGE
357-018	TREKER MAGNIT UNIVERSAL YAMAHA RX	22
357-032	TREKER REM MOBIL	21
385-181	TRIMER LINE MODEL KOTAK	62
383-063	TUTUP TELINGA GAGANG PLASTIK	176
383-062	TUTUP TELINGA SILIKON	176
U		
373-001	UKURAN ANGIN 3 FUNGSI	02
373-205	UKURAN ANGIN DIAL	03
373-202	UKURAN ANGIN NO. 7 /160 PSI	03
373-203	UKURAN ANGIN NO. 9 /200 PSI	03
V		
387-273	VERTICAL LIFTING CLAMP 3 T	150
387-274	VERTICAL LIFTING CLAMP 5 T	150
W		
367-020	WATERPASS ALUMINIUM KUNING 80"	42
367-021	WATERPASS MAGNET HEAVY DUTY 18"	42
367-022	WATERPASS MAGNET HEAVY DUTY 24"	42
367-041	WATERPASS TORPEDO 9"	42
385-070	WEBBING SLING 1 T X 1 M UNGU	146
385-071	WEBBING SLING 1 T X 2 M UNGU	146
385-072	WEBBING SLING 1 T X 3 M UNGU	146
385-073	WEBBING SLING 1 T X 4 M UNGU	146
385-074	WEBBING SLING 1 T X 5 M UNGU	146
385-075	WEBBING SLING 1 T X 6 M UNGU	146
385-076	WEBBING SLING 1 T X 8 M UNGU	146
385-077	WEBBING SLING 1 T X 10 M UNGU	146
385-085	WEBBING SLING 2 T X 3 M HIJAU	146
385-086	WEBBING SLING 2 T X 4 M HIJAU	146
385-087	WEBBING SLING 2 T X 5 M HIJAU	146
385-088	WEBBING SLING 2 T X 6 M HIJAU	146
385-089	WEBBING SLING 2 T X 8 M HIJAU	146
385-079	WEBBING SLING 2 T X 2 M HIJAU	146
385-078	WEBBING SLING 2 T X 1 M HIJAU	146
385-097	WEBBING SLING 5 T X 4 M MERAH	146
385-098	WEBBING SLING 5 T X 6 M MERAH	146
385-131	WEBBING SLING 5 T X 3 M MERAH	146
385-132	WEBBING SLING 5 T X 5 M MERAH	146
385-151	WEBBING SLING 6 T X 3 M COKLAT	146
385-099	WEBBING SLING 6 T X 4 M COKLAT	146
385-152	WEBBING SLING 6 T X 5 M COKLAT	146
385-100	WEBBING SLING 6 T X 6 M COKLAT	146
385-153	WEBBING SLING 6 T X 8 M COKLAT	146
385-156	WEBBING SLING 8 T X 6 M BIRU	146
385-161	WEBBING SLING 10 T X 6 M ORANGE	146
385-162	WEBBING SLING 10 T X 8 M ORANGE	146
385-163	WEBBING SLING 10 T X 10 M ORANGE	146
385-094	WEBBING SLING 4 T X 4 M ABU-ABU	146
385-095	WEBBING SLING 4 T X 5 M ABU-ABU	146
385-096	WEBBING SLING 4 T X 6 M ABU-ABU	146
385-121	WEBBING SLING 4 T X 3 M ABU-ABU	146
385-122	WEBBING SLING 4 T X 8 M ABU-ABU	146
385-141	WEBBING SLING 3 T X 3 M KUNING	146
385-090	WEBBING SLING 3 T X 4 M KUNING	146
385-091	WEBBING SLING 3 T X 5 M KUNING	146
385-092	WEBBING SLING 3 T X 6 M KUNING	146
385-093	WEBBING SLING 3 T X 8 M KUNING	146
385-142	WEBBING SLING 3 T X 10 M KUNING	146

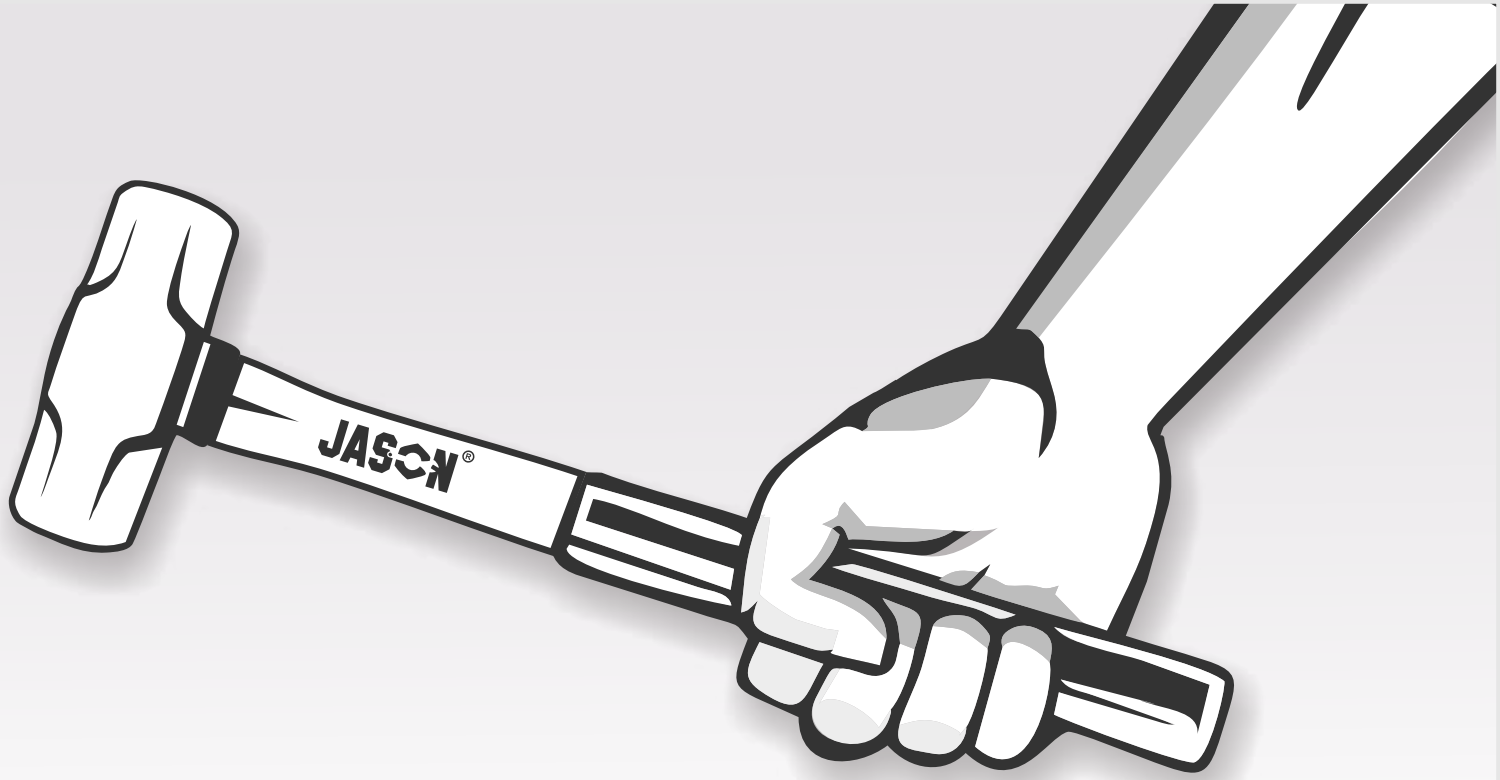

JASON[®]
tools n hardware



AIR NAILER
STAPLES ANGIN



ITEM NO.	TYPE	BOX	CTN
358-005	F-30	1 pc	10 pcs

Max air pressure: 4-7 Bar
Nail : 10-30 mm

AIR STAPLER
STAPLES ANGIN



ITEM NO.	TYPE	BOX	CTN
358-007	1022J	1 pc	10 pcs

Max air pressure: 4-7 bar
Nail square: 6-22 mm



AIR CHUCK 3 FUNCTION
UKURAN ANGIN 3 FUNGSI

ITEM NO.	SIZE	BOX	CTN
373-001	0-220 psi	10 pcs	20 pcs

Quick coupler
Aluminum body in yellow color

TIRE NIPPLES
NEPEL PENGISI ANGIN MODEL BULAT

ITEM NO.	SIZE	BOX	CTN
373-002	8 mm	20 pcs	200 pcs



38 gr, For air hose
Precision leak - proof seal
With build - in shut - off valve

TIRE NIPPLES
NEPEL PENGISI ANGIN MODEL JEPIT

ITEM NO.	SIZE	BOX	CTN
373-003	3/8"	100 pcs	600 pcs



27 gr, For air hose
Precision leak - proof seal
With build - in shut - off valve



AIR CHUCK



ITEM NO	TYPE	BOX	CTN
373-011	TD-11	10 pcs	100 pcs

Quick coupler
Chrome body finished
Dual head for convenient use

TIRE GAUGE

UKURAN ANGIN



ITEM NO.	SIZE	BOX	CTN
373-202	No. 7 /160 psi	5 pcs	50 pcs
373-203	No. 9 /200 psi	5 pcs	50 pcs

Nickel plated tire gauge

TIRE DIAL METAL AIR GAUGE

UKURAN ANGIN DIAL



ITEM NO.	SIZE	BOX	CTN
373-205	100 psi	50 pcs	100 pcs

High accuracy pressure



AIR DUSTER

ITEM NO.	TYPE	BOX	CTN
372-001	3 IN 1	10 sets	100 sets

Aluminum body in yellow color



AIR DUSTER

ITEM NO.	TYPE	BOX	CTN
372-006	DG - 10 - 1	25 pcs	100 pcs

Aluminum body in yellow color



AIR DUSTER

ITEM NO.	TYPE	BOX	CTN
372-007	DG - 10 - 2	25 pcs	100 pcs

Aluminum body in yellow color



AIR DUSTER

ITEM NO.	TYPE	BOX	CTN
372-008	DG - 10 - 3	25 pcs	100 pcs

Aluminum body in yellow color



AIR BLOW GUN

ITEM NO.	SIZE	BOX	CTN
372-009	100 mm	10 pcs	100 pcs
372-010	250 mm	10 pcs	100 pcs



Yellow plastic body with PM coupler nozzle

SPRAY GUN

SPED DUCO TABUNG BAWAH

ITEM NO.	TYPE	BOX	CTN
377-101	F - 75 S	1 pc	20 pcs



Cup capacity: 750 cc
Air pressure: 70 psi

SPRAY GUN

SPED DUCO TABUNG ATAS

ITEM NO.	TYPE	BOX	CTN
377-102	F - 75 G	1 pc	20 pcs



Cup capacity: 400 cc
Air pressure: 70 psi

AIR PAINT BRUSH

SPED LUKIS

ITEM NO.	SIZE	BOX	CTN
377-111	0.3 mm x 7 cc	1 set	30 sets



Nozzle diameter: 0,3 mm
Cup Capacity: 7 cc



SPRAY GUN

SPED DUCO TABUNG ATAS

ITEM NO.	TYPE	BOX	CTN
377-103	F - 100 G	1 pc	20 pcs

Nozzle size: 1, 1,3, 1,5, 1,8 mm
Cup capacity : 400 ml
Air pressure: 45-80 psi



SPRAY GUN

SPED DUCO TABUNG BAWAH

ITEM NO.	TYPE	BOX	CTN
377-104	F - 100 S	1 pc	20 pcs

Nozzle size: 1, 1,3, 1,5, 1,8 mm
Cup capacity: 750 ml
Air pressure: 45-80 psi



SPRAY GUN

SPED DUCO TABUNG ATAS

ITEM NO.	TYPE	BOX	CTN
377-105	R - 2 G	1 pc	20 pcs

Nozzle size: 0,5 mm
Cup capacity: 200 ml
Air pressure: 22-60 psi



SPRAY GUN

SPED DUCO TABUNG ATAS

ITEM NO.	TYPE	BOX	CTN
377-106	R - 3 G	1 pc	20 pcs

Nozzle size: 0,5 mm
Cup capacity: 200 ml
Air pressure: 22-60 psi



TIRE LEVER

ALAT PENGUNGKIT BAN



ITEM NO.	SIZE	BOX	CTN
373-102	10"	25 pcs	100 pcs
373-103	12"	25 pcs	100 pcs
373-104	16"	10 pcs	30 pcs

Black nickel finished

TIRE REPAIR KIT

ALAT TUBLES BAN GAGANG BESI 7 PCS



ITEM NO.	BOX	CTN
373-113	25 sets	50 sets

High quality material
Iron grips for punching holes & rubber clamps

TIRE REPAIR KIT

ALAT TUBLES BAN 8 PCS



ITEM NO.	BOX	CTN
373-114	12 sets	72 sets

High quality material

REFILL TIRE REPAIR

REFILL TUBLES BAN 25 PCS



ITEM NO.	SIZE	BOX	CTN
373-115	4" x 6 mm	25 ktk	100 ktk
373-116	8" x 6 mm	10 ktk	50 ktk

High quality material



GREASE GUN MINI

ITEM NO.	SIZE	BOX	CTN
359-010	100 cc	1 pc	40 pcs

Steel body construction



GREASE GUN HITAM

ITEM NO.	SIZE	BOX	CTN
359-011	500 cc	1 pc	10 pcs

Steel body construction



GREASE GUN MERAH

ITEM NO.	SIZE	BOX	CTN
359-012	500 cc	1 pc	10 pcs

Steel body construction



GREASE GUN HOSE SELANG GREASE GUN

ITEM NO.	SIZE	BOX	CTN
359-100	13"	24 pcs	96 pcs

Pressure up to 4.500 psi



OIL SUCTION GUN



ITEM NO.	SIZE	BOX	CTN
359-031	500 cc	1 pc	20 pcs

Chrome plated

PLASTIC OIL CAN

OIL CAN TABUNG TRANSPARAN



ITEM NO.	SIZE	BOX	CTN
359-032	350 cc	10 pcs	60 pcs

Aluminum pipe and brass nozzle
Plastic material

METAL OIL CAN

OIL CAN TABUNG BESI 200 CC



ITEM NO.	SIZE	BOX	CTN
359-033	200 cc	10 pcs	60 pcs

Flexible hose
Steel material

METAL OIL CAN

OIL CAN TABUNG BESI 300 CC



ITEM NO.	SIZE	BOX	CTN
359-034	300 cc	10 pcs	60 pcs

Flexible hose
Steel material



WASHING GUN
SPED SOLAR

ITEM NO	TYPE	BOX	CTN
372-011	MT - 2	1 pc	12 pcs

Cup capacity: 1.000 cc
High quality



OIL PUMP
POMPA OLI

ITEM NO	SIZE	CTN
359-041	32 mm	6 sets

With flexible hose inside



PVC OIL PUMP
POMPA OLI PVC

ITEM NO	SIZE	CTN
359-043	32 mm	10 sets

Used for : chemical and oil
High quality material



HAND TEST PUMP
TEST PUMP

ITEM NO.	SIZE	BOX	CTN
359-042	60 bar	1 pc	4 pcs

Pressure: 60 kg/cm²
Water tank capacity: 5 liter



HYDRAULIC BOTTLE JACK

DONGKRAK BOTOL



ITEM NO	SIZE	BOX	CTN
387-001	2 ton	1 pc	6 pcs
387-002	4 ton	1 pc	6 pcs
387-003	6 ton	1 pc	4 pcs
387-004	10 ton	1 pc	4 pcs
387-005	16 ton	1 pc	2 pcs
387-006	20 ton	1 pc	2 pcs
387-007	30 ton	1 pc	2 pcs
387-008	50 ton	1 pc	1 pc

Heavy duty

HYDRAULIC FLOOR JACK

DONGKRAK BUAYA



ITEM NO	SIZE	CTN
387-010	2 ton	1 set

Lifting range: 135-335 mm

Weight 7,5 kg

HD HYDRAULIC FLOOR JACK

DONGKRAK BUAYA HEAVY DUTY



ITEM NO	SIZE	CTN
387-017	3 ton	1 set

Lifting range: 5 5/16" - 19 1/2"

Weight 34 kg

HD JACK STAND

GANJALAN DONGKRAK



ITEM NO.	SIZE	BOX	CTN
387-052	3 ton	1 set	4 sets
387-053	6 ton	1 set	2 sets

Safety lock

High grade steel construction



FULLER BLADE 13 PCS

ITEM NO.	SIZE	BOX	CTN
367-106	0.05 - 1.0 mm	10 sets	100 sets

100 x 13 blade

FILTER DRIVER

KUNCI OLI FILTER 3 KAKI



ITEM NO.	SIZE	BOX	CTN
346-191	65 - 110 mm	1 pc	50 pcs

Use 1/2" bar extension

STRAP WRENCH

KUNCI OLI FILTER KULIT



ITEM NO.	SIZE	BOX	CTN
346-192	9"	10 pcs	50 pcs

Range: Ø 60 - 140
Handle mirror polished

CHAIN WRENCH

KUNCI OLI FILTER RANTAI



ITEM NO.	SIZE	BOX	CTN
346-195	9"	10 pcs	30 pcs

Range: Ø 30 - 160
Handle mirror polished



SAFETY TRAFFIC BATON

TONGKAT LAMPU LALU LINTAS



ITEM NO.	SIZE	CTN
345-190	4x54 cm	50 pcs

Three-stage switch provides flashing
Steady light or off
PVC, outer tube + ABS handle
2xD battery (not included)

BOOSTER CABLE

KABEL AKI



ITEM NO.	SIZE	BOX	CTN
386-022	200 A x 2,5 m	1 set	8 sets
386-023	300 A x 2,5 m	1 set	8 sets

Multi stranded copper for high conductivity
6, 12, or 24V use

BATTERY HYDROMETER

HIDROMETER AIR AKI



ITEM NO.	SIZE	BOX	CTN
386-401	220 mm	20 pcs	100 pcs

Fast and accurate testing
Colour coded

WORKING LAMP

LAMPU KERJA



ITEM NO.	SIZE	BOX	CTN
392-001	5M - AC 220V / 60W	1 pc	12 pcs

Convenient on-off switch



MECHANIC CREEPER
ALAS MEKANIK

ITEM NO.	SIZE	CTN
345-211	40"	1 pc

Heavy duty, fiber material



TOWING SNAP
TALI PENARIK MOBIL

ITEM NO.	SIZE	CTN
345-210	16 mm x 4 m	20 pcs

Nylon material
Hook with strong safety latch



RATCHET TIE DOWN
TALI PENGIKAT BAK TRUK

ITEM NO.	SIZE	CTN
385-080	2" x 6 m	10 pcs
385-081	2" x 8 m	10 pcs
385-082	2" x 10 m	10 pcs
385-083	2" x 12 m	10 pcs

Break strength \leq 3.000 kgf
Safe working load \leq 1.500 kgf



CLEAN CHAMOIS

KAIN LAP PEMBERSIH SERBAGUNA



ITEM NO.	SIZE	BOX	CTN
373-031	430x310x2mm	50 pcs	100 pcs

Easy remove dirt & stain
High suction quality material



O TYPE ASSORTMENT KIT

O-RING SET 407 PCS

ITEM NO.	SIZE	BOX	CTN
390-016	3 mm - 50 mm	10 sets	20 sets

Metric size



O TYPE ASSORTMENT KIT

O-RING SET 407 PCS

ITEM NO.	SIZE	BOX	CTN
390-017	1/8" - 2"	10 sets	20 sets

Inch size

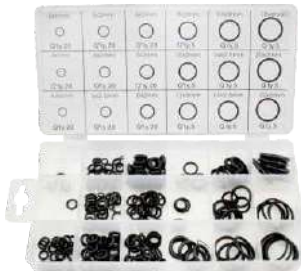

O-RING ASSORTMENT KIT

O-RING SET 225 PCS

ITEM NO.	SIZE	CTN
390-018	3 mm - 22 mm	24 sets

Metric size



O-RING ASSORTMENT KIT

O-RING SET 225 PCS

ITEM NO.	SIZE	CTN
390-019	3/32" - 3/4"	24 sets

Inch size



SPONGE POLISHING PAD

SPON GELOMBANG + VELCRO

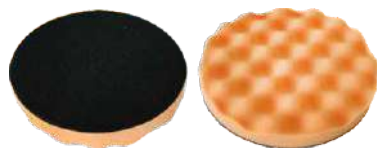

ITEM NO.	SIZE	CTN
373-041	35 x 125 mm	100 pcs
373-040	35 x 200 mm	100 pcs

Velcro type

WOOL POLISHING PAD

REFILL WOOL POLES



ITEM NO.	SIZE	CTN
373-500	5"	100 pcs
373-501	7"	100 pcs

Wrap type

WOOL POLISHING PAD

REFILL WOOL POLES + VELCRO



ITEM NO.	SIZE	CTN
373-502	7"	100 pcs

Velcro & border type

RUBBER BACKING PAD

BANTALAN PLASTIK POLES + VELCRO



ITEM NO.	SIZE	CTN
373-503	100 mm	250 pcs
373-507	125 mm	120 pcs
373-504	180 mm	60 pcs

Max 8.500 rpm
For use with sanding disc or polisher



VALVE ADJUSTABLE WRENCH

KUNCI KLEP SEPEDA MOTOR MODEL L

ITEM NO.	SIZE	BOX	CTN
346-586	8 mm x 130 mm	25 pcs	100 pcs

Motorcycle valve adjustment



PISTON RING COMPRESSOR

ITEM NO.	SIZE	BOX	CTN
390-011	No. 3 (5" x 75 mm)	12 pcs	36 pcs
390-012	No. 4 (7" x 100 mm)	12 pcs	36 pcs
390-013	No. 7 (50 - 150 mm)	1 pc	40 pcs

Ratchet system with easy release switch
Spring steel construction

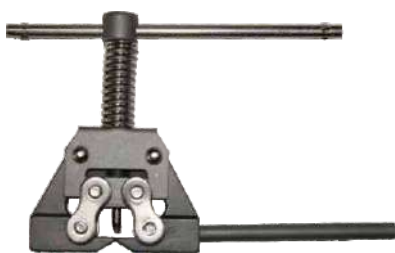

CHAIN DISASSEMBLER

ALAT POTONG RANTAI SEPEDA MOTOR

ITEM NO.	SIZE	BOX	CTN
373-110	25 - 60 mm	5 pcs	50 pcs

Can be used for any motorcycle
Black nickel finished
High quality product



BIG CHAIN BREAKER

ALAT POTONG RANTAI SERBAGUNA

ITEM NO.	SIZE	BOX	CTN
373-111	420 - 530 Chain	6 pcs	48 pcs

Portable size
Black nickel finished
Easy for cutting motorcycle chain



METAL TOOL BOX

TOOL BOX 2 SUSUN KUNING



ITEM NO.	SIZE	CTN
391-005	15" (38x15,5x18 cm)	12 pcs
391-006	20" (50x21x22 cm)	6 pcs

International quality standard
Steel and PVC construction

PLASTIC TOOL BOX

TOOL BOX PLASTIK



ITEM NO.	SIZE	CTN
391-019	12" (30,5x13,5x13,5 cm)	12 pcs
391-018	15" (40x17,5x21,5 cm)	6 pcs

High quality material

TOOL KIT SET

TOOL SET



ITEM NO.	TYPE	BOX	CTN
391-023	100 pcs	1 set	6 sets

- 4 pcs x Allen wrenches (3,4,5,6mm)
- 1 pc x Terminal Pliers -8"
- 1 pc x Groove joint pliers 9"
- 1 pc x Ratchet handle-3/8"
- 11 pcs x Screwdriver tips
- 9 pcs x Sockets- (1/4"x 5, 6, 7, 8, 9, 10, 11, 12, 13mm)
- 6 pcs x Sockets- (3/8"x 10, 11, 12, 15, 17, 19mm) 5pcs x Combination Spanner- (8, 10, 12, 13, 14mm)
- 1 pc x Adapter-1/4"x25mm
- 4 pcs x Screwdriver (PH:6x38, 6x100mm, Slotted:6x38, 6x100mm) 1pc x Combination Pliers 6"
- 1 pc x Type "T" handle-1/4"
- 1 pc x Hammer-300g
- 54 pcs x Cable terminals

PVC box

BEARING PULLER

TREKER BEARING



ITEM NO.	TYPE	BOX	CTN
390-001	AB - 1	10 pcs	60 pcs
390-002	AB - 2	10 pcs	30 pcs

AB - 1 : 19-35 mm

AB - 2 : 24-55 mm

GEAR PULLER

TREKER 3 KAKI



ITEM NO.	SIZE	BOX	CTN
357-001	3"	1 pc	40 pcs
357-002	4"	1 pc	30 pcs
357-003	6"	1 pc	10 pcs
357-004	8"	1 pc	6 pcs
357-005	10"	1 pc	4 pcs
357-006	12"	1 pc	2 pcs

3 jaws zinc plated gear puller

GEAR PULLER

TREKER 2 FUNGSI



ITEM NO.	SIZE	BOX	CTN
357-007	4"	1 pc	20 pcs
357-008	6"	1 pc	10 pcs
357-009	8"	1 pc	4 pcs

2 & 3 jaws, high quality material



MOTORCYCLE'S PULLER

TREKER MAGNIT

ITEM NO.	TYPE	BOX	CTN
357-014	Honda Tiger	6 pcs	36 pcs

High precision



TIE ROD END PULLER

TREKER BALL JOINT

ITEM NO.	SIZE	CTN
357-031	20 - 40 mm	20 pcs

High quality material



DISC BRAKE SPREADER

TREKER REM MOBIL

ITEM NO.	SIZE	CTN
357-032	15,2 x 7,3 x 2,1 cm	10 pcs

High quality material



MOTORCYCLE'S PULLER
TREKER MAGNIT UNIVERSAL

ITEM NO.	TYPE	BOX	CTN
357-018	Yamaha RX	6 pcs	36 pcs

Can be used for: C70, V80, RX, RXS, RXK, LS, V75, MIO, CB, GL Pro, S90, CG, Vario, Prima, Grand, Supra, Win, RC, RGR, Shogun, Smash, Crystal, Satria, GP, A100, GTO, KH, Mochin



MOTORCYCLE'S PULLER
TREKER MAGNIT UNIVERSAL

ITEM NO.	TYPE	BOX	CTN
357-019	Honda Neotex	6 pcs	36 pcs

Can be used for: C700, Tiger, Proneotek, Maxneotek, Kharisma, Ninja, Smash, Thunder 125



MOTORCYCLE'S PULLER
TREKER MAGNIT UNIVERSAL

ITEM NO.	TYPE	BOX	CTN
357-020	Yamaha Force - 1	6 pcs	36 pcs

Can be used for: Vespa, PX, F1ZR, Alfa, V70, CB, GL



HEXAGON WRECKING BAR

ALAT CABUT PAKU

ITEM NO.	SIZE	BOX	CTN
347-501	12 mm x 300 mm	1 pc	30 pcs
347-502	16 mm x 450 mm	1 pc	20 pcs
347-503	16 mm x 600 mm	1 pc	20 pcs

Heavy duty steel construction

GLASS CUTTER

ALAT POTONG KACA



ITEM NO.	TYPE	BOX	CTN
362-042	TC - 90	6 pcs	240 pcs

Yellow transparent handle
High quality material

16 PCS GRAVER SET

ALAT UKIR 16 PCS



ITEM NO.	BOX	CTN
371-210	12 sets	72 sets

Multifunction graver
Sharp & easy to use

MAGNETIC SOCKET 4 PCS



ITEM NO.	SIZE	BOX	CTN
348-173	8 mm	12 sets	48 sets

4 pcs bit set
Magnetic tip



3 IN 1 TILE CUTTER

ALAT POTONG KERAMIK 3 IN 1

ITEM NO.	SIZE	BOX	CTN
365-001	400 mm	1 set	4 sets
365-003	600 mm	1 set	4 sets

Fit for floor strainer
Able to cut most ceramic tiles

HEAVY DUTY TILE CUTTER

ALAT POTONG KERAMIK HEAVY DUTY



ITEM NO.	SIZE	BOX	CTN
365-002	600 mm	1 set	4 sets

Able to cut most ceramic & granite tiles

PROFESSIONAL LASER TILE CUTTER

ALAT POTONG KERAMIK LASER



ITEM NO.	SIZE	BOX	CTN
365-004	1000 mm	1 set	2 sets

Max. length: 1000 mm, Max. thickness: 14 mm
Able to cut most ceramic & granite tiles

ALLOY CUTTING WHEEL FOR TILE CUTTER

MATA POTONG KERAMIK



ITEM NO.	SIZE	BOX	CTN
365-101	16 x 6,5 x 3mm	50 pcs	500 pcs
365-102	22 x 10,5 x 2mm	50 pcs	500 pcs

Professional
TCT material



CAULKING GUN
ALAT SODOK LEM

ITEM NO.	SIZE	BOX	CTN
360-001	9"	12 pcs	24 pcs

Suitable for any silicone sealant



CAULKING GUN
ALAT SODOK LEM NYLON

ITEM NO.	SIZE	BOX	CTN
360-002	9"	25 pcs	50 pcs

Suitable for any silicone sealant
Elastic nylon materials in black color



CAULKING GUN
ALAT SODOK LEM PROFESIONAL

ITEM NO.	SIZE	CTN
360-003	9"	24 pcs

Suitable for any silicone sealant
Heavy duty



CAULKING GUN
ALAT SODOK LEM TABUNG ALUMINIUM

ITEM NO.	SIZE	CTN
360-004	9" (550 g)	24 pcs
360-005	15" (650 g)	24 pcs

Suitable for sausage sealant
Smooth trigger action
Comfortable handle grip



NEUTRAL SILICONE SEALANT
LEM SILICONE TABUNG NETRAL

ITEM NO.	COLOR	CTN
360-101	Bening	25 pcs
360-102	Hitam	25 pcs
360-103	Putih	25 pcs
360-104	Abu - abu	25 pcs

Made in Korea
Weatherproof & permanently flexible

GUTTER REPAIR TAPE
LAKBAN TALANG



ITEM NO.	SIZE	CTN
360-111	5 cm x 1 m	150 pcs

Weatherproof

CYANOACRYLATE ADHESIVE
SUPER GLUE



ITEM NO.	SIZE	CTN
360-114	3 g	288 pcs

Made in Taiwan
Very strong adhesive glue
Use on a variety of surface and material
Suitable for use in house hold appliances, handicraft and other



WATERPROOF ABRASIVE CLOTH

AMPLAS KAIN WATERPROOF



ITEM NO	SIZE	BOX	CTN
369-091	# 0	100 lbr	1000 lbr
369-092	# 1	100 lbr	1000 lbr
369-093	# 1,5	100 lbr	1000 lbr
369-094	# 2	100 lbr	500 lbr
369-095	# 2,5	50 lbr	500 lbr
369-096	# 3	50 lbr	500 lbr

Electrostatic coated abrasive
Waterproof

ABRASIVE PAPER

AMPLAS KERTAS



ITEM NO.	SIZE	BOX	CTN
369-111	# 100	100 lbr	500 lbr
369-112	# 120	100 lbr	500 lbr
369-113	# 150	100 lbr	500 lbr
369-114	# 180	100 lbr	500 lbr
369-115	# 220	100 lbr	500 lbr
369-116	# 240	100 lbr	1000 lbr
369-117	# 280	100 lbr	1000 lbr
369-118	# 320	100 lbr	1000 lbr
369-119	# 360	100 lbr	1000 lbr
369-120	# 400	100 lbr	1000 lbr
369-121	# 500	100 lbr	1000 lbr
369-122	# 600	100 lbr	1000 lbr
369-123	# 800	100 lbr	1000 lbr
369-124	# 1000	100 lbr	1000 lbr

Electrostatic coated abrasive, waterproof

PAINT & VARNISH REMOVER PAD

MATA GERINDA AMPLAS CAT



ITEM NO.	SIZE	BOX	CTN
373-506	100 mm	5 pcs	100 pcs

Material: Support disc using fiber, medium hard
Used: Cleaning paint, levelling putty, Smoothing wood
Max 15200 rpm



FIBER DISC

AMPLAS BULAT

ITEM NO.	SIZE	BOX	CTN
369-100	4" #16	100 pcs	1000 pcs
369-101	4" #24	100 pcs	1000 pcs
369-102	4" #36	100 pcs	1000 pcs
369-104	4" #60	100 pcs	1000 pcs
369-105	4" #80	100 pcs	1000 pcs
369-106	4" #100	100 pcs	1000 pcs
369-107	4" #120	100 pcs	1000 pcs
369-108	4" #150	100 pcs	1000 pcs

Long lasting fiber disc

ALUMINUM OXIDE ABRASIVE CLOTH BELT

AMPLAS ROL



ITEM NO.	SIZE	CTN
369-131	4" x 40 m #40	5 rol
369-133	4" x 40 m #60	5 rol
369-134	4" x 40 m #80	5 rol
369-135	4" x 40 m #100	5 rol
369-136	4" x 40 m #120	5 rol
369-137	4" x 40 m #150	5 rol
369-138	4" x 40 m #180	5 rol
369-139	4" x 40 m #220	5 rol
369-140	4" x 40 m #240	5 rol

Long lasting aluminum oxide abrasive cloth belt, Water resistant

ALUMINUM OXIDE ABRASIVE CLOTH BELT

AMPLAS ROL



ITEM NO.	SIZE	CTN
369-142	2" x 50 m #80	10 rol
369-143	2" x 50 m #100	10 rol
369-144	2" x 50 m #120	10 rol
369-145	2" x 50 m #150	10 rol
369-146	2" x 50 m #180	10 rol
369-147	2" x 50 m #220	10 rol
369-148	2" x 50 m #240	10 rol

Long lasting aluminum oxide abrasive cloth belt, Water resistant



SANDER CLOTH DISC W/ VELCRO

AMPLAS BULAT VELCRO

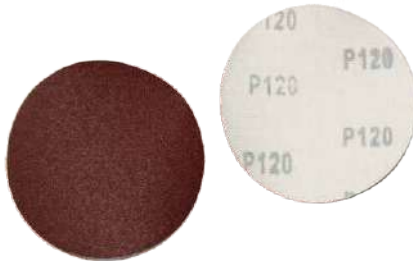

ITEM NO.	SIZE	BOX	CTN
369-151	4" #36	500 pcs	2000 pcs
369-152	4" #60	500 pcs	2000 pcs
369-153	4" #80	500 pcs	2000 pcs
369-154	4" #100	500 pcs	2000 pcs
369-155	4" #120	500 pcs	2000 pcs
369-156	4" #150	500 pcs	2000 pcs
369-157	4" #180	500 pcs	2000 pcs
369-158	4" #240	500 pcs	2000 pcs

Best material
10 pcs/pack

FLAP DISC



ITEM NO	SIZE	BOX	CTN
369-193	4" #60	20 pcs	200 pcs
369-194	4" #80	20 pcs	200 pcs
369-195	4" #100	20 pcs	200 pcs
369-196	4" #120	20 pcs	200 pcs

Max 12.300 Rpm
Max 80 m/s

POLISHING BUFF CUP

MATA GERINDA POLES WOOL



ITEM NO.	SIZE	BOX	CTN
373-505	4" x 10 mm	10 pcs	500 pcs

Used for: stainless, brass, copper
RPM 11.000, Max 80 m/s

NON WOVEN POLISHING WHEEL

MATA GERINDA POLES NON WOVEN



ITEM NO.	SIZE	BOX	CTN
373-508	100 mm	10 pcs	500 pcs

Used for: stainless, metal
RPM max 11.000



MOUNTED STONE SET

BATU OSCO

ITEM NO.	SIZE	BOX	CTN
369-001	5 pcs (6 mm - 5 pcs)	10 sets	100 sets
369-002	10 pcs (6 mm - 5 pcs) (3 mm - 5 pcs)	10 sets	100 sets

Multi shape fit for any electric tools

OIL STONE FOR PLANNER BLADE

BATU ASAH PISAU KETAM



ITEM NO.	SIZE	BOX	CTN
369-003	150 X 90 X 20 mm	1 pc	30 pcs

Oil stone #1000
For HSS planer blade

COMBINATION SHARPENING STONE

BATU GOSOK ABU-ABU



ITEM NO.	SIZE	CTN
369-013	6"	50 pcs
369-014	8"	50 pcs

High quality



COLD CHISEL

BETEL BESI MODEL PAYUNG

ITEM NO.	SIZE	BOX	CTN
349-001	8"	6 pcs	60 pcs
349-002	10"	6 pcs	60 pcs
349-003	12"	6 pcs	60 pcs

Rubber handle
45# Carbon steel



CENTER PUNCH

DRIP CENTER KHROM

ITEM NO.	SIZE	BOX	CTN
350-023	6 x 3/16	1 dzn	20 dzn

Chrome vanadium
Knurled body for better grip



STAINLESS STEEL SPRING HINGES

ENGSEL VER SS

ITEM NO	SIZE	BOX	CTN
351-214	3"	1 psg	40 psg
351-215	4"	1 psg	30 psg
351-216	5"	1 psg	24 psg
351-217	6"	1 psg	24 psg

Stainless steel
High quality material



STAINLESS STEEL HINGES

ENGSEL NYLON BEARING SS

ITEM NO	SIZE	BOX	CTN
351-218	3" x 2,5" x 2,0 mm	12 psg	72 psg
351-219	4" x 3,0" x 2,3 mm	12 psg	48 psg
351-220	5" x 3,0" x 2,3 mm	12 psg	48 psg

Stainless steel
High quality material

5 IN 1 MULTI BLADE SAW

GERGAJI 5 IN 1

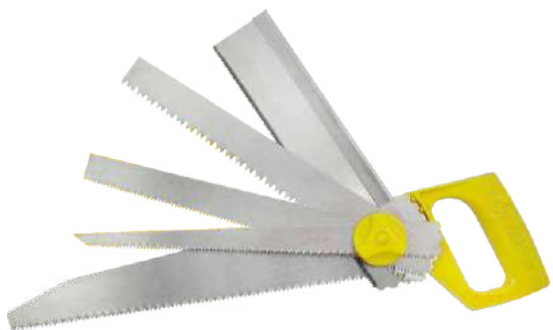

ITEM NO.	SIZE	BOX	CTN
363-003	5 pcs	12 sets	48 sets
	12 TPI		
	8 TPI		
	8 TPI		
	7 TPI		
	5 TPI		

Strong metal handle
Hardened & tempered bright steel lacquered blade

PLASTIC MITRE BOX WITH TENON SAW SET

GERGAJI SUDUT 2 SECTION



ITEM NO.	SIZE	CTN
363-005	300 mm	12 sets

Alloy steel material
High precision angle measurement 45° & 90°
For wood

BOW SAW

GERGAJI BUSUR 3 IN 1



ITEM NO.	SIZE	BOX	CTN
363-041	300 mm	12 sets	24 sets

Interchangeable saw blades for wood and iron saw blades



HANSAW

GERGAJI GOROK 2 SECTION

ITEM NO.	SIZE	BOX	CTN
363-011	18"	6 pcs	5 dzn
363-012	20"	6 pcs	5 dzn

Durable polished
Two sectioned steel blade

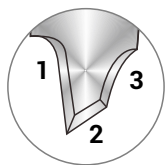

HANSAW

GERGAJI GOROK GAGANG KAYU 3 SECTION

ITEM NO.	SIZE	BOX	CTN
363-021	18"	6 pcs	60 pcs
363-022	20"	6 pcs	60 pcs

Wooden handle
Alloy steel three section sharpened



HANSAW SET

GERGAJI GOROK 3 SECTION 2 PCS

ITEM NO.	SIZE	BOX	CTN
363-030	18" & 20"	6 sets	12 sets

Alloy steel three section sharpened

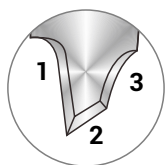

HANSAW RUBBER HANDLE

GERGAJI GOROK GAGANG KARET 3 SECTION

ITEM NO.	SIZE	BOX	CTN
363-031	18"	10 pcs	40 pcs
363-032	20"	10 pcs	40 pcs

Three section sharpened
Alloy steel material



BOLT CLIPPER
GUNTING BETON

ITEM NO.	SIZE	BOX	CTN
362-001	18"	1 pc	20 pcs
362-002	24"	1 pc	10 pcs
362-003	30"	1 pc	5 pcs
362-004	36"	1 pc	5 pcs
362-005	42"	1 pc	2 pcs

Heavy duty carbon steel blade
Tubular handle wrapped in rubber



AMERICAN TYPE TIN SNIP
GUNTING SENG

ITEM NO.	SIZE	BOX	CTN
362-021	8"	6 pcs	48 pcs
362-022	10"	6 pcs	36 pcs

Heavy duty hardened steel blade
Comfortable handle



AVIATION TIN SNIP
GUNTING SENG & GALVALUM MODEL LURUS

ITEM NO.	SIZE	BOX	CTN
362-112	10"	6 pcs	60 pcs

Chrome vanadium alloy steel blade
Cuts up to 1.5 mm cold rolled steel or 0.9 mm stainless steel



MIRROR POLISH SCRAPER

KAPI CAT MIRROR POLISH



ITEM NO.	SIZE	BOX	CTN
377-031	4 pcs (2", 3", 4", 5")	12 sets	144 sets

High elasticity
Mirror polished

SCRAPER

KAPI CAT



ITEM NO.	SIZE	BOX	CTN
377-036	1,5"	1 dzn	20 dzn
377-037	2"	1 dzn	20 dzn
377-038	2,5"	1 dzn	20 dzn
377-039	3"	1 dzn	20 dzn
377-040	4"	1 dzn	20 dzn

Mirror polished
Fine wooden handle with strong steel plate

SCRAPER

KAPI CAT STAINLESS GG KARET



ITEM NO.	SIZE	BOX	CTN
377-042	1,5"	1 dzn	20 dzn
377-043	2"	1 dzn	20 dzn
377-044	2,5"	1 dzn	20 dzn
377-045	3"	1 dzn	20 dzn
377-046	4"	1 dzn	20 dzn

Comfortable use
Stainless steel material



STONE PENCIL

KAPUR BESI

ITEM NO.	SIZE	BOX	CTN
345-401	12 pcs (12 x 5 x 125 mm)	1 ktk	100 ktk

High quality material



SUCTION DENT PULLER

KOP KACA 3 KAKI

ITEM NO.	SIZE	BOX	CTN
362-044	5"	1 pc	10 pcs

Used for: window, mirror, door



PVC PLASTIC WATER BIBCOCK W/ NOZZLE

KRAN TAMAN PVC BALING PUTIH

ITEM NO.	SIZE	BOX	CTN
378-301	1/2"	12 pcs	240 pcs

Plastic PVC material



PVC PLASTIC WATER BIBCOCK W/ NOZZLE

KRAN TAMAN PVC FLAT PUTIH

ITEM NO.	SIZE	BOX	CTN
378-302	1/2"	12 pcs	240 pcs

Plastic PVC material



ZINC ALLOY WATER BIBCOCK POLISHED CHROME

KRAN AIR BALING KHROM



ITEM NO.	SIZE	BOX	CTN
378-303	1/2"	12 pcs	144 pcs

Classic model
Zinc alloy finished plating chrome

ZINC ALLOY WATER BIBCOCK POLISHED CHROME

KRAN AIR FLAT KHROM



ITEM NO.	SIZE	BOX	CTN
378-304	1/2"	12 pcs	144 pcs

Decorative model
Zinc alloy finished plating chrome

ZINC ALLOY WATER BIBCOCK POLISHED CHROME

KRAN WASTAFEL BALING KHROM



ITEM NO.	SIZE	BOX	CTN
378-305	1/2"	12 pcs	72 pcs

Classic sink faucet
Zinc alloy finished plating chrome

PAINT BRUSH

KUAS CAT BULU PUTIH



ITEM NO.	SIZE	BOX	CTN
377-001	1"	1 dzn	108 dzn
377-002	1,5"	1 dzn	50 dzn
377-003	2"	1 dzn	30 dzn
377-004	2,5"	1 dzn	30 dzn
377-005	3"	1 dzn	30 dzn
377-006	4"	1 dzn	20 dzn
377-007	5"	1 dzn	10 dzn

Light wooden handle in bright yellow color

PAINT BRUSH

KUAS CAT BULU HITAM



ITEM NO.	SIZE	BOX	CTN
377-011	1"	1 dzn	50 dzn
377-012	1,5"	1 dzn	50 dzn
377-013	2"	1 dzn	40 dzn
377-014	2,5"	1 dzn	30 dzn
377-015	3"	1 dzn	20 dzn
377-016	4"	1 dzn	10 dzn
377-017	5"	1 dzn	10 dzn

Thick bristle filament

PAINT BRUSH

KUAS CAT POLYESTER



ITEM NO.	SIZE	BOX	CTN
377-020	1"	1 dzn	50 dzn
377-021	1,5"	1 dzn	50 dzn
377-022	2"	1 dzn	30 dzn
377-023	2,5"	1 dzn	30 dzn
377-024	3"	1 dzn	20 dzn
377-025	4"	1 dzn	10 dzn

Thick polyester filament

PAINT BRUSH

KUAS CAT GG PLASTIK BULU PUTIH



ITEM NO.	SIZE	BOX	CTN
377-081	1"	1 dzn	50 dzn
377-082	1,5"	1 dzn	30 dzn
377-083	2"	1 dzn	20 dzn
377-084	2,5"	1 dzn	20 dzn

High quality material



ROLLER BRUSH

KUAS ROL

ITEM NO.	SIZE	CTN
377-009	9"	5 dzn

Used for both water and oil paint
Easy to clean
100% wool

REFILL PAINT ROLLER

REFILL KUAS ROL



ITEM NO.	SIZE	CTN
377-008	9"	120 pcs

All type of paint surface
Used for both water and oil paint
100% wool

ROLLER BRUSH

KUAS ROL KAPAL



ITEM NO.	SIZE	CTN
377-010	4" x 24"	120 pcs

Used for both water and oil paint
Easy to clean
100% wool

REFILL PAINT ROLLER

REFILL KUAS ROL KAPAL



ITEM NO.	SIZE	BOX	CTN
377-019	4"	12 pcs	600 pcs

All type of paint surface
Used for both water and oil paint
100% wool



FIBERGLASS MEASURING TAPE

METERAN FIBER

ITEM NO.	SIZE	BOX	CTN
368-001	30 m	1 pc	20 pcs
368-002	50 m	1 pc	20 pcs
368-003	100 m	1 pc	10 pcs

Big number easy to read

MEASURING TAPE

METERAN ROL KUNING



ITEM NO.	SIZE	BOX	CTN
368-022	5 m x 19 mm	12 pcs	60 pcs
368-023	7,5 m x 25 mm	12 pcs	48 pcs

Auto lock with easy release button

MEASURING TAPE

METERAN ROL BODI KARET



ITEM NO.	SIZE	BOX	CTN
368-027	5 m x 19 mm	6 pcs	60 pcs
368-028	7,5 m x 25 mm	6 pcs	48 pcs

Rubber wrapped for better grip



MEASURING WHEEL

METERAN JALAN

ITEM NO.	TYPE	CTN
368-041	4 digits	10 pcs

Made in Taiwan
Accuracy up to 10 cm

TRY SQUARE

SIKU TUKANG ALUMINIUM



ITEM NO.	SIZE	BOX	CTN
377-222	10"	12 pcs	120 pcs
377-223	12"	12 pcs	120 pcs

Full aluminum material

ALUMINUM LEVEL
WATERPASS ALUMINIUM KUNING

ITEM NO.	SIZE	CTN
367-020	80"	20 pcs



High quality aluminum material
Accuracy up to 1 mm / m (0.057)

HEAVY DUTY ALUMINUM LEVEL W/ MAGNET
WATERPASS MAGNET HEAVY DUTY

ITEM NO.	SIZE	CTN
367-021	18"	40 pcs
367-022	24"	40 pcs



ISO 9002 certificate
Accuracy up to 1 mm / m (0.057)

TORPEDO LEVEL
WATERPASS TORPEDO

ITEM NO.	SIZE	BOX	CTN
367-041	9"	10 pcs	60 pcs



High quality PVC material
Magnetic bottom



SLEDGE HAMMER

PALU BATU GAGANG FIBER



ITEM NO.	SIZE	BOX	CTN
354-001	2 lb x 30 cm	6 pcs	24 pcs
354-002	3 lb x 35 cm	6 pcs	12 pcs
354-003	4 lb x 40 cm	6 pcs	12 pcs
354-004	6 lb x 90 cm	1 pc	6 pcs
354-005	8 lb x 90 cm	1 pc	6 pcs
354-006	10 lb x 90 cm	1 pc	4 pcs
354-007	12 lb x 90 cm	1 pc	4 pcs
354-008	14 lb x 90 cm	1 pc	4 pcs

Comfortable rubber grip

SLEDGE HAMMER

PALU BATU



ITEM NO.	SIZE	CTN
354-121	2 lb x 400 gram	20 pcs
354-122	3 lb x 400 gram	16 pcs
354-123	4 lb x 400 gram	12 pcs
354-124	6 lb x 400 gram	8 pcs
354-125	8 lb x 400 gram	6 pcs
354-126	10 lb x 400 gram	6 pcs
354-127	12 lb x 400 gram	6 pcs
354-128	14 lb x 400 gram	4 pcs
354-129	16 lb x 400 gram	4 pcs
354-130	18 lb x 400 gram	2 pcs
354-131	20 lb x 400 gram	2 pcs

High quality material

Yellow color finish with powder coating

BRASS SLEDGE HAMMER

PALU KUNINGAN GAGANG PVC



ITEM NO.	SIZE	CTN
354-141	2 lb x 280 mm	24 pcs
354-142	3 lb x 300 mm	20 pcs
354-143	4 lb x 320 mm	20 pcs
354-144	6 lb x 610 mm	15 pcs
354-145	8 lb x 820 mm	15 pcs
354-146	10 lb x 820 mm	10 pcs

Brass head material

PVC handle with rubber wrapped which is comfortable for grip



COPPER SLEDGE HAMMER
PALU TEMBAGA GAGANG PVC

ITEM NO.	SIZE	CTN
354-151	2 lb x 280 mm	24 pcs
354-152	3 lb x 300 mm	20 pcs
354-153	4 lb x 320 mm	20 pcs
354-154	6 lb x 620 mm	15 pcs
354-155	8 lb x 820 mm	15 pcs
354-156	10 lb x 820 mm	10 pcs

Copper head material
PVC handle with rubber wrapped
Comfortable grip

RUBBER MALLET
PALU KARET GAGANG FIBER



ITEM NO.	SIZE	BOX	CTN
354-051	8 oz	6 pcs	60 pcs
354-052	12 oz	6 pcs	48 pcs
354-053	16 oz	6 pcs	36 pcs
354-054	24 oz	6 pcs	24 pcs

Elastic & durable
Used to flatten the plate work
PVC handle with rubber wrapped
Comfortable grip

VINYL HAMMER
PALU FINIL



ITEM NO.	SIZE	BOX	CTN
354-101	1.0 lb	6 pcs	36 pcs
354-102	1.5 lb	6 pcs	24 pcs
354-103	2.0 lb	6 pcs	24 pcs

Ideal for heavy and effective blows
Manufactured from high quality SBR material which is oil resistant
The hollow head has steel particles



CLAW HAMMER

PALU KAMBING GAGANG FIBER



ITEM NO.	SIZE	BOX	CTN
354-021	8 oz	6 pcs	36 pcs
354-022	13 oz	6 pcs	36 pcs
354-023	16 oz	6 pcs	24 pcs

Fiberglass handle with rubber grip

CLAW HAMMER

PALU KAMBING GAGANG KAYU



ITEM NO.	SIZE	BOX	CTN
354-031	8 oz	6 pcs	60 pcs
354-033	16 oz	6 pcs	48 pcs

Comfortable grip

AMERICAN TYPE MAGNET CLAW HAMMER

PALU KAMBING PIPA BESI



ITEM NO.	SIZE	BOX	CTN
354-034	8 oz	6 pcs	36 pcs
354-035	13 oz	6 pcs	36 pcs
354-036	16 oz	6 pcs	24 pcs

1,2 mm tube & PVC grip

CLAW HAMMER

PALU KAMBING MIRROR POLISHED



ITEM NO.	SIZE	BOX	CTN
354-083	16 oz	6 pcs	24 pcs

Full steel body with comfortable rubber grip
Mirror polished



STUBBY CLAW HAMMER

PALU KAMBING MINI

ITEM NO.	SIZE	BOX	CTN
354-084	8 oz	6 pcs	48 pcs

Lightweight for work
Handle comfortable rubber grip

BALLPEIN HAMMER

PALU KONDE GAGANG FIBER



ITEM NO.	SIZE	BOX	CTN
354-011	8 oz	6 pcs	72 pcs
354-012	12 oz	6 pcs	60 pcs
354-013	16 oz	6 pcs	48 pcs
354-014	24 oz	6 pcs	24 pcs
354-015	32 oz	6 pcs	24 pcs

Fiberglass handle with rubber grip

BALLPEIN HAMMER

PALU KONDE GAGANG KAYU



ITEM NO.	SIZE	BOX	CTN
354-041	8 oz	6 pcs	72 pcs
354-042	12 oz	6 pcs	60 pcs
354-043	16 oz	6 pcs	48 pcs
354-044	24 oz	6 pcs	24 pcs
354-045	32 oz	6 pcs	24 pcs

Comfortable grip

CARPENTER HAMMER

PALU TUKANG GAGANG FIBER



ITEM NO.	SIZE	BOX	CTN
354-071	140 g	6 pcs	60 pcs
354-072	210 g	6 pcs	60 pcs
354-073	240 g	6 pcs	60 pcs

For professional use



CHIPPING HAMMER

PALU KETOK KARAT



ITEM NO.	SIZE	BOX	CTN
354-063	300 g	6 pcs	48 pcs
354-065	500 g	6 pcs	36 pcs

High quality material

WELDING HAMMER

PALU KETOK LAS



ITEM NO.	SIZE	BOX	CTN
354-066	300 g	6 pcs	60 pcs

High quality material



CONCRETE NAIL
PAKU BETON GALVANIS

ITEM NO.	SIZE	CTN
351-001	3 X 1"	50 ktk
351-002	3 X 1 1/4"	50 ktk
351-003	3 X 1 1/2"	50 ktk
351-004	3,6 X 2"	50 ktk
351-005	4 X 2 1/2"	50 ktk
351-006	4,2 X 3"	50 ktk
351-007	4,5 X 4"	50 ktk

Hardened & tempered high carbon steel
Comes in PVC box, 400 gr / box



BLACK CONCRETE NAIL
PAKU BETON HITAM

ITEM NO.	SIZE	CTN
351-010	25 x 2 mm	50 ktk
351-011	40 x 3 mm	50 ktk
351-012	50 x 3 mm	50 ktk
351-013	60 x 3 mm	50 ktk
351-014	75 x 4,2 mm	50 ktk
351-015	100 x 4,2 mm	50 ktk

Hardened & tempered high carbon steel
Comes in PVC box, 400 gr / box



BAR CUTTER
ALAT POTONG BETON

ITEM NO.	SIZE	CTN
362-008	20 mm	1 set
362-009	28 mm	1 set
362-010	32 mm	1 set

Heavy duty
Steel handle rectangle

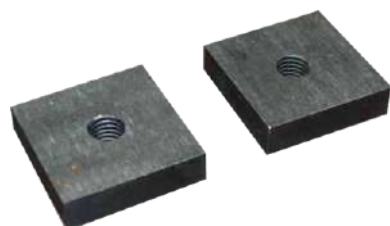

BAR CUTTING BLADE
MATA POTONG BETON

ITEM NO.	SIZE	CTN
362-070	20 mm	100 sets
362-071	28 mm	50 sets
362-072	32 mm	60 sets

Heavy Duty Steel



CHALK LINE WITH VIVAL
PENGGARIS BENANG + KAPUR

ITEM NO.	SIZE	BOX	CTN
368-210	30 m (Waterpass)	12 sets	36 sets

Easy to use



P.T.F.E THREAD SEAL TAPE
SEAL TAPE

ITEM NO.	SIZE	BOX	CTN
394-010	1/2"x10mx0.075mm	12 rol	1.200 rol

High quality material



P.T.F.E THREAD SEAL TAPE
SEAL TAPE

ITEM NO.	SIZE	BOX	CTN
394-011	3/4"x15mx0.2mm	60 rol	300 rol

High quality material



P.T.F.E THREAD SEAL TAPE
SEAL TAPE

ITEM NO.	SIZE	BOX	CTN
394-013	1"x15mx0.075mm	30 rol	300 rol

High quality material



BRICKLAYING TROWEL

SENDOK SEMEN BULAT WARNA BIRU

ITEM NO.	SIZE	BOX	CTN
377-068	6"	1 dzn	6 dzn
377-069	7"	1 dzn	6 dzn
377-070	8"	1 dzn	6 dzn

Carbon steel tip



BRICKLAYING TROWEL

SENDOK SEMEN OVAL WARNA BIRU

ITEM NO.	SIZE	BOX	CTN
377-071	6"	1 dzn	10 dzn
377-072	7"	1 dzn	10 dzn
377-073	8"	1 dzn	5 dzn

Carbon steel tip



BRICKLAYING TROWEL

SENDOK SEMEN BULAT WARNA SILVER

ITEM NO.	SIZE	BOX	CTN
377-074	6"	1 dzn	10 dzn
377-075	7"	1 dzn	10 dzn
377-076	8"	1 dzn	10 dzn

Heavy duty steel construction



BRICKLAYING TROWEL

SENDOK SEMEN OVAL WARNA SILVER

ITEM NO.	SIZE	BOX	CTN
377-077	6"	1 dzn	10 dzn
377-078	7"	1 dzn	10 dzn
377-079	8"	1 dzn	10 dzn

Heavy duty steel construction



FLAT SAND SHOVEL

SEKOP PASIR GAGANG FIBER PAPAN

ITEM NO.	SIZE	CTN
343-001	40" x 2 mm	1 dzn

High quality material



TAPER SAND SHOVEL

SEKOP PASIR GAGANG FIBER LANCIP

ITEM NO.	SIZE	CTN
343-002	41" x 2 mm	1 dzn

High quality material



SAND SHOVEL WOODEN HANDLE

SEKOP SEPADAN GAGANG KAYU

ITEM NO.	SIZE	CTN
343-003	40" x 2 mm	1 dzn

High quality material



PLASTERING TROWEL

SENDOK SEMEN PERSEGI STAINLESS RATA

ITEM NO.	SIZE	BOX	CTN
377-171	11"	12 pcs	60 pcs

Strong PVC handle
Stainless steel plate



PLASTERING TROWEL

SENDOK SEMEN PERSEGI STAINLESS GERIGI

ITEM NO.	SIZE	BOX	CTN
377-172	11"	6 pcs	60 pcs

Strong PVC handle
Stainless steel plate



WIRE BRUSH

SIKAT BAJA HITAM GAGANG PLASTIK



ITEM NO.	SIZE	BOX	CTN
361-001	6 baris	12 pcs	120 pcs

High carbon steel brush

WIRE BRUSH

SIKAT BAJA GAGANG KUNING



ITEM NO.	SIZE	BOX	CTN
361-003	6 baris	1 dzn	5 dzn

High quality material
High carbon steel brush

HAND STEEL WIRE BRUSH

SIKAT BAJA KUNING GAGANG PLASTIK



ITEM NO.	SIZE	BOX	CTN
361-020	240 mm	12 pcs	120 pcs

High carbon steel brush
Easy to remove surface

WIRE BRUSH SET

SIKAT KOMBINASI



ITEM NO.	SIZE	BOX	CTN
361-022	7"	25 sets	100 sets
361-021	9"	25 sets	100 sets

3 pcs/set: nylon, brass & stainless steel brush



WALLBOARD SAW
GERGAJI GYPSUM

ITEM NO.	SIZE	BOX	CTN
363-033	150 mm	12 pcs	72 pcs

Exchangeable blade
Sharpening teeth

HACKSAW 2 IN 1

STANG GERGAJI BESI 2 IN 1



ITEM NO.	SIZE	BOX	CTN
364-001	12"	12 pcs	36 pcs

Blade storage on top bar
Blade can be positioned for 45° or 90° cutting

SQUARE TUBULAR HACKSAW FRAME

STANG GERGAJI BESI PROFESIONAL



ITEM NO.	SIZE	BOX	CTN
364-002	12"	6 pcs	36 pcs

Professional
For cutting metals, tubes and fiberglass in 45° & 90°
Ideal for use with bimetal and high speed blade

HACKSAW FRAME

STANG GERGAJI BESI PROFESIONAL 2 IN 1



ITEM NO.	SIZE	BOX	CTN
364-003	12"	6 pcs	36 pcs

Professional
For cutting metals, tubes and fiberglass in 45° & 90°



CHROME HACKSAW FRAME
STANG GERGAJI BESI KHROM



ITEM NO.	SIZE	BOX	CTN
364-004	8" - 12"	6 pcs	36 pcs

Chrome polished

HACKSAW FRAME
STANG GERGAJI BESI MODEL OVAL GG PLASTIK



ITEM NO.	SIZE	BOX	CTN
364-010	12"	12 pcs	48 pcs

Strong & light weight
Blade can be positioned for 45° or 90° cutting

MAGNETIC WOOD CHISEL
TATAH KAYU GG PLASTIK



ITEM NO.	SIZE	BOX	CTN
371-241	5/16"	6 pcs	60 pcs
371-242	3/8"	6 pcs	60 pcs
371-243	1/2"	6 pcs	60 pcs
371-244	5/8"	6 pcs	60 pcs
371-245	3/4"	6 pcs	60 pcs
371-246	1"	6 pcs	60 pcs
371-247	1 1/4"	6 pcs	60 pcs
371-248	1 1/2"	6 pcs	60 pcs

Chrome vanadium material



SHELF BRACKET

SIKU RAK

ITEM NO.	SIZE	BOX	CTN
377-231	4" x 5" x 0,8 mm	1 dzn	12 dzn
377-232	5" x 6" x 0,8 mm	1 dzn	12 dzn
377-233	6" x 8" x 0,8 mm	1 dzn	12 dzn
377-234	8" x 10" x 0,8 mm	1 dzn	6 dzn
377-235	10" x 12" x 1,0 mm	1 dzn	6 dzn
377-236	12" x 14" x 1,0 mm	1 dzn	5 dzn

White Color
1 dzn = 12 pairs



FOLDABLE SHELF BRACKET

SIKU RAK STAINLESS LIPAT

ITEM NO.	SIZE	BOX	CTN
377-241	8"	20 psg	40 psg
377-242	10"	20 psg	40 psg
377-243	12"	20 psg	40 psg
377-244	14"	20 psg	40 psg

Stainless steel material
Strong and durable



K-TYPE FOLDABLE SHELF BRACKET

SIKU RAK PUTIH LIPAT

ITEM NO.	SIZE	BOX	CTN
377-246	8"	20 psg	40 psg
377-247	10"	20 psg	40 psg
377-248	12"	20 psg	40 psg
377-249	14"	20 psg	40 psg

Iron plate, white color
Strong and durable



AUGER BIT



ITEM NO.	SIZE	BOX	CTN
371-101	5/16" X 200 mm	12 pcs	120 pcs
371-102	5/16" X 300 mm	12 pcs	120 pcs
371-103	3/8" X 200 mm	12 pcs	120 pcs
371-104	3/8" X 300 mm	12 pcs	120 pcs
371-105	1/2" X 200 mm	12 pcs	120 pcs
371-106	1/2" X 300 mm	12 pcs	120 pcs
371-107	5/8" X 200 mm	12 pcs	120 pcs
371-108	5/8" X 300 mm	12 pcs	120 pcs

Solid steel tempered & polished

AUGER BIT 2 FUNGSI



ITEM NO.	SIZE	BOX	CTN
371-109	3/8" X 400 mm	1 pc	45 pcs
371-110	1/2" X 400 mm	1 pc	72 pcs
371-111	5/8" X 400 mm	1 pc	72 pcs
371-112	3/4" X 400 mm	1 pc	30 pcs

Solid steel tempered & polished

MORTISING CHISEL & BIT SET

MATA BOR CHISEL



ITEM NO.	SIZE	BOX	CTN
353-340	5/16" x 3/4"	20 pcs	80 pcs
353-341	3/8" x 3/4"	20 pcs	80 pcs
353-342	1/2" x 3/4"	20 pcs	80 pcs
353-343	5/8" x 3/4"	20 pcs	80 pcs

High quality material
Fast cutting hard & soft wood

FLAT WOOD BITS

MATA BOR KAYU TINCOATED



ITEM NO.	SIZE	BOX	CTN
353-043	5/8"	50 pcs	300 pcs
353-044	3/4"	50 pcs	300 pcs
353-045	7/8"	50 pcs	300 pcs

Carbon steel drill bits
Hardened & tempered tips



FLAT WOOD DRILL BITS

MATA BOR KAYU TINCOATED

ITEM NO.	SIZE	BOX	CTN
353-005	6 pcs (10, 13, 16, 19, 22, 25 mm)	6 sets	60 sets

Carbon steel drill bits
Hardened & tempered tips



ADJUSTABLE HOLE DRILLS WOOD

ITEM NO.	SIZE	BOX	CTN
371-123	30 - 120 mm	5 sets	60 sets

Alloy tool steel (M-2) cutter blades & center drill bit
For wood



STEEL HOLE SAW

HOLE SAW SET 7 BLADE

ITEM NO.	SIZE	BOX	CTN
371-121	25 mm	10 sets	60 sets
371-122	50 mm	10 sets	60 sets

High carbon steel
High precision hole drills



HOLE SAW SET FOR WOOD

HOLE SAW KAYU 11 PCS

ITEM NO.	SIZE	CTN
371-125	Specification: 8 pcs hole saw (19 - 64 mm) 3/4"(19 mm), 7/8"(22 mm) 1"(25 mm), 1 1/8"(29 mm) 1 1/2"(38 mm), 1 3/4"(44 mm), 2"(51 mm) 2 1/2"(64 mm) 2 pcs Arbors: 3/8" Hex 1 pc Hex Key: Wrench 4 mm	20 sets

High carbon steel, hardened teeth
Used for cutting wood, wallboard, plastics & soft materials



4 PCS GIMLETS

MATA BOR UNCEK 4 PCS



ITEM NO.	SIZE	BOX	CTN
350-024	3, 4, 5, 6 mm	12 sets	120 sets

To make screw holes on the doors hinges and wood

DIAMOND GRINDING WHEEL DOUBLE



ITEM NO.	SIZE	CTN
366-013	4"	25 pcs
366-014	5"	25 pcs

Double side
Blade sharpener for TCT material

MULTIPURPOSE CIRCULAR SAW

MULTICUTTER



ITEM NO.	SIZE	BOX	CTN
366-101	4" x 40T	10 pcs	100 pcs

Max rpm: 14.500/mins, Max 80 m/s
TCT blade

CONTINUOUS DIAMOND BLADE

DIAMOND CUP WHEEL



ITEM NO.	SIZE	BOX	CTN
366-202	75 mm	10 pcs	40 pcs
366-201	100 mm	5 pcs	50 pcs

High quality material

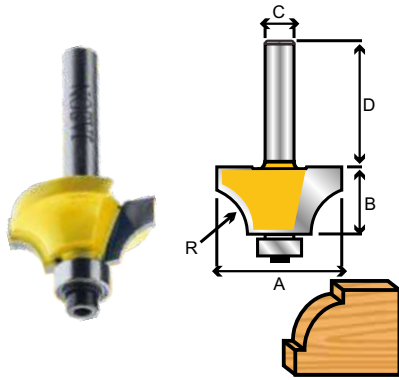

BEADING BIT

MATA BEADING BIT TCT

ITEM NO.	SIZE	A mm	B mm	C mm	D mm	R mm	BOX	CTN
371-001	1/4"x5/32"	19	9.5	6.35	32	3.2	5 pcs	200 pcs
371-002	1/4"x3/16"	22.2	9.5	6.35	32	4.8	5 pcs	200 pcs
371-003	1/4"x1/4"	25.4	11.1	6.35	32	6.35	5 pcs	200 pcs
371-004	1/4"x5/16"	28.6	12.7	6.35	32	7.9	5 pcs	200 pcs

Long lasting TCT YG8 material

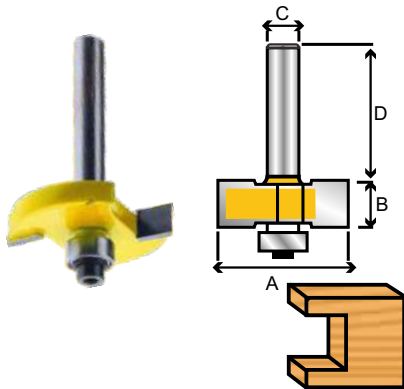

SLOTING BIT

MATA SLOTTING BIT TCT

ITEM NO.	SIZE	A mm	B mm	C mm	D mm	BOX	CTN
371-011	1/4"x3 mm	31.8	3.2	6.35	38	5 pcs	200 pcs
371-012	1/4"x4 mm	31.8	4.0	6.35	38	5 pcs	200 pcs
371-013	1/4"x5 mm	31.8	4.8	6.35	38	5 pcs	200 pcs
371-014	1/4"x6 mm	31.8	6.35	6.35	38	5 pcs	200 pcs
371-015	1/4"x8 mm	31.8	7.9	6.35	38	5 pcs	200 pcs

Long lasting TCT YG8 material

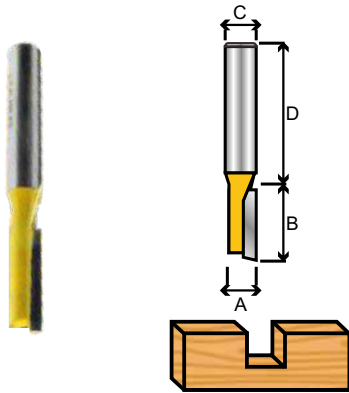

STRAIGHT BIT

MATA STRAIGHT BIT TCT

ITEM NO.	SIZE	A mm	B mm	C mm	D mm	BOX	CTN
371-021	1/4"x3 mm	3	15	6.35	32	5 pcs	200 pcs
371-022	1/4"x4 mm	4	15	6.35	32	5 pcs	200 pcs
371-023	1/4"x5 mm	5	20	6.35	32	5 pcs	200 pcs
371-024	1/4"x6 mm	6	20	6.35	32	5 pcs	200 pcs
371-025	1/4"x8 mm	8	20	6.35	32	5 pcs	200 pcs

Long lasting TCT YG8 material

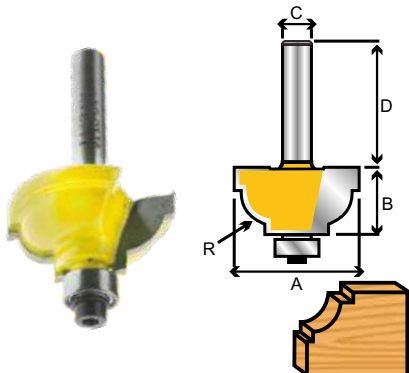

CLASSICAL COVE BIT

MATA CLASSICAL COVE BIT TCT

ITEM NO.	SIZE	A mm	B mm	C mm	D mm	R mm	BOX	CTN
371-032	1/4"x3/16"	27	12.7	6.35	32	4.8	5 pcs	200 pcs
371-033	1/4"x1/4"	30.2	14.3	6.35	32	6.35	5 pcs	200 pcs
371-034	1/4"x5/16"	33.3	15.9	6.35	32	7.9	5 pcs	200 pcs

Long lasting TCT YG8 material

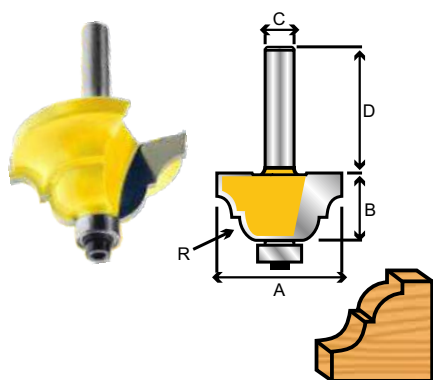

CLASSICAL ROMAN OGEE BIT

MATA CLASSICAL ROMAN OGEE BIT TCT

ITEM NO.	SIZE	A mm	B mm	C mm	D mm	R mm	BOX	CTN
371-042	1/4"x3/16"	31.8	15.9	6.35	32	4.8	5 pcs	200 pcs
371-043	1/4"x1/4"	38.1	19	6.35	32	6.35	5 pcs	200 pcs
371-044	1/4"x5/16"	46.1	22.2	6.35	32	7.96	5 pcs	200 pcs

Long lasting TCT YG8 material

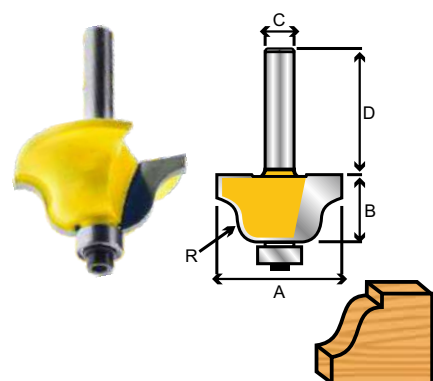

ROMAN OGEE BIT

MATA ROMAN OGEE BIT TCT

ITEM NO.	SIZE	A mm	B mm	C mm	D mm	R mm	BOX	CTN
371-052	1/4"x3/16"	32	14	6.35	32	4.76	5 pcs	200 pcs
371-053	1/4"x1/4"	34.9	16.8	6.35	32	6.35	5 pcs	200 pcs
371-054	1/4"x5/16"	41.8	22.2	6.35	32	7.95	5 pcs	200 pcs

Long lasting TCT YG8 material

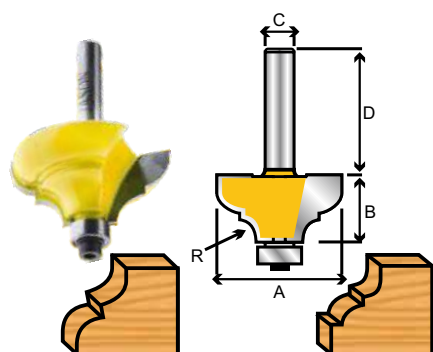

CLASSICAL OGEE BIT

MATA CLASSICAL OGEE BIT TCT

ITEM NO.	SIZE	A mm	B mm	C mm	D mm	R mm	BOX	CTN
371-062	1/4"x3/16"	31.8	14.3	6.35	32	4.8	5 pcs	200 pcs
371-063	1/4"x1/4"	38.1	17.5	6.35	32	6.35	5 pcs	200 pcs
371-064	1/4"x5/16"	46.1	22.2	6.35	32	7.96	5 pcs	200 pcs

Long lasting TCT YG8 material

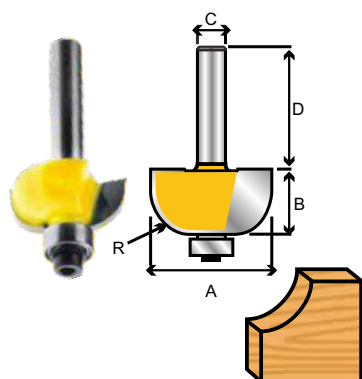

COVE BIT

MATA COVE BIT TCT

ITEM NO.	SIZE	A mm	B mm	C mm	D mm	R mm	BOX	CTN
371-072	1/4"x3/16"	22.5	4.76	6.35	32	4.76	5 pcs	200 pcs
371-073	1/4"x1/4"	25.7	9.5	6.35	32	6.35	5 pcs	200 pcs
371-074	1/4"x5/16"	28.9	7.96	6.35	32	7.96	5 pcs	200 pcs

Long lasting TCT YG8 material



BRUSH CUTTER BLADE
PISAU POTONG RUMPUT

ITEM NO.	SIZE	BOX	CTN
362-141	2T x 305 mm	1 pc	100 pcs

Black finished



BRUSH CUTTER BLADE
PISAU POTONG RUMPUT BULAT

ITEM NO.	SIZE	BOX	CTN
362-142	40T x 250 mm	1 pc	50 pcs

Black finished



TRIMMER LINE
TRIMER LINE MODEL KOTAK

ITEM NO.	SIZE	CTN
385-181	2,4 mm x 15 m	120 pcs

Square string used for electric lawn mower
Material: Nylon 100%



TRIMMER HEAD
KEPALA TRIMMER LINE

ITEM NO.	SIZE	CTN
385-182	25,4mm (hole Diameter)	100 sets

Material: Made of die cast metal, nylon 100%

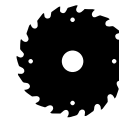

CONTINUOUS DIAMOND BLADE

DIAMOND WHEEL BASAH



ITEM NO.	SIZE	BOX	CTN
366-011	4,5" (114mm)	10 pcs	100 pcs

Diameter blade: 114 x 1.8 x 12 x 20/16
 For concrete, marble, granite, etc.
 Maximum speed 14.500/mins

SEGMENTED DIAMOND BLADE

DIAMOND WHEEL KERING



ITEM NO.	SIZE	BOX	CTN
366-012	4,5" (114mm)	10 pcs	100 pcs

Diameter blade: 114 x 1.8 x 12 x 20/16
 For concrete, marble, granite, etc.
 Maximum speed 14.500/mins

CONTINUOUS RIM TURBO

DIAMOND WHEEL TURBO



ITEM NO.	SIZE	BOX	CTN
366-111	4" (105mm)	10 pcs	200 pcs

For marble, granite, tile, concrete
 Max rpm: 14.500/mins
 TCT blade

DIAMOND WHEEL

DIAMOND WHEEL SUPER THIN



ITEM NO.	SIZE	BOX	CTN
366-015	4,5" (115mm)	10 pcs	100 pcs

APILKASI UNTUK DIAMOND CUTTING WHEELS		
Continuous Rim (Basah)	Turbo	Segmented (Kering)
Keramik, Ubin, porselin dan marmer	Batu alam & buatan, beton, Batu bata, Marmer, Granit dan Fiberglass	Beton, Granit, Batu Bata, Aspal dan Materi tahan panas

Max 13800 rpm, 80m/s



MASONRY DRILL
MATA BOR BETON

ITEM NO.	SIZE	BOX	CTN
353-011	4 mm x 75 mm	100 pcs	400 pcs
353-012	5 mm x 85 mm	100 pcs	400 pcs
353-013	6 mm x 100 mm	100 pcs	400 pcs
353-014	8 mm x 120 mm	100 pcs	400 pcs
353-015	10 mm x 120 mm	100 pcs	400 pcs
353-017	12 mm x 135 mm	50 pcs	100 pcs
353-019	14 mm x 150 mm	50 pcs	100 pcs
353-020	16 mm x 145 mm	50 pcs	100 pcs

Strong impact drill



MASONRY DRILL
MATA BOR BETON PANJANG

ITEM NO.	SIZE	BOX	CTN
353-030	6 mm x 300 mm	50 pcs	300 pcs
353-031	8 mm x 300 mm	50 pcs	200 pcs
353-032	10 mm x 300 mm	50 pcs	200 pcs
353-033	12 mm x 300 mm	50 pcs	200 pcs
353-034	14 mm x 300 mm	30 pcs	150 pcs
353-035	16 mm x 300 mm	25 pcs	100 pcs

Long and strong impact drill



CONCRETE DRILL BITS
MATA BOR BETON SET 5 PCS

ITEM NO.	SIZE	BOX	CTN
353-090	4, 5, 6, 8, 10 mm	10 sets	100 sets

Strong impact drill



SDS CONCRETE DRILL BITS
MATA BOR BETON SDS SET 5 PCS

ITEM NO.	SIZE	BOX	CTN
353-094	5, 6, 8, 10, 12 mm	10 sets	80 sets

Strong SDS drill bits

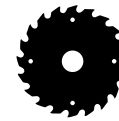

ADJUSTABLE HOLE CUTTER CERAMIC



ITEM NO.	SIZE	BOX	CTN
371-120	20 - 94 mm	10 pcs	80 pcs

Zinc alloy tungsten carbide tipped drill
Maximum drill speed 500/mins
For Ceramic

GLASS DRILL

MATA BOR KACA 5 PCS



ITEM NO.	SIZE	BOX	CTN
353-250	4, 6, 8, 10, 12 mm	1 set	40 sets

For glass, tile, granite
Diamond material

DIAMOND GLASS HOLE CUTTER

MATA BOR KACA LAPIS INTAN



ITEM NO.	SIZE	BOX	CTN
353-251	8 mm x 6 mm	180 pcs	360 pcs
353-252	8 mm x 8 mm	50 pcs	200 pcs
353-253	8 mm x 10 mm	50 pcs	200 pcs
353-254	8 mm x 12 mm	50 pcs	200 pcs
353-255	8 mm x 15 mm	25 pcs	100 pcs
353-256	8 mm x 20 mm	25 pcs	100 pcs
353-257	8 mm x 22 mm	25 pcs	100 pcs
353-258	8 mm x 25 mm	25 pcs	100 pcs
353-259	8 mm x 30 mm	25 pcs	100 pcs
353-260	8 mm x 32 mm	25 pcs	100 pcs
353-261	8 mm x 35 mm	25 pcs	100 pcs
353-262	8 mm x 40 mm	25 pcs	100 pcs
353-263	8 mm x 42 mm	25 pcs	100 pcs
353-264	8 mm x 45 mm	25 pcs	100 pcs
353-265	8 mm x 50 mm	25 pcs	100 pcs
353-266	8 mm x 55 mm	12 pcs	60 pcs
353-267	8 mm x 60 mm	12 pcs	60 pcs

For drilling holes in: Glass, marble, limestone, slate, glass jars ceramics porcelain, granite, stained glass ceramic, tile porcelain, tile stone



H.S.S STEP DRILLS

MATA BOR MULTIFUNGSI

ITEM NO.	SIZE	BOX	CTN
353-006	4 - 12mm (5 step) 4, 6, 8, 10, 12mm	20 pcs	100 pcs
353-007	4 - 20mm (9 step) 4, 6, 8, 10, 12, 14, 16, 18, 20mm	10 pcs	100 pcs
353-008	4 - 32mm (15 step) 4, 6, 8, 10, 12, 14, 16, 18, 20, 22, 24, 26, 28, 30, 32mm	10 pcs	100 pcs

HSS

Function to perforate thin plates according to size by using a drilling machine

HOLE CUTTER

HOLE CUTTER BESI HSS



ITEM NO.	SIZE	BOX	CTN
371-131	16 mm	10 pcs	200 pcs
371-132	19 mm	10 pcs	200 pcs
371-133	20 mm	10 pcs	200 pcs
371-134	22 mm	10 pcs	200 pcs
371-135	24 mm	10 pcs	200 pcs
371-136	25 mm	10 pcs	200 pcs
371-137	28 mm	10 pcs	200 pcs
371-138	30 mm	10 pcs	200 pcs
371-139	32 mm	10 pcs	200 pcs
371-140	40 mm	10 pcs	100 pcs
371-141	42 mm	10 pcs	100 pcs
371-142	50 mm	10 pcs	100 pcs

M2, HSS material

HOLE SAW SET FOR METAL

HOLE SAW BESI 13 PCS



ITEM NO.	SIZE	CTN
371-126	Specification: 9 pcs hole saw (19 - 64 mm) 3/4"(19 mm), 7/8"(22 mm) 1"(25 mm), 1 1/8"(29 mm) 1 1/2"(38 mm), 1 3/4"(44 mm), 2"(51 mm) 2 1/4"(57 mm), 2 1/2"(64 mm) 2 pcs Arbors: 3/8" Hex 1 pc Hex Key: Wrench 4 mm	10 sets

Hardened teeth

HSS Bi-metal

**H.S.S TAPERED SHANK TWIST DRILL**

MATA BOR KONES JIS



ITEM NO.	SIZE	BOX	CTN
353-051	14 mm	50 pcs	100 pcs
353-053	15 mm	25 pcs	50 pcs
353-054	15.5 mm	25 pcs	50 pcs
353-055	16 mm	25 pcs	50 pcs
353-056	16.5 mm	25 pcs	50 pcs
353-058	17.5 mm	25 pcs	50 pcs
353-060	18.5 mm	25 pcs	50 pcs
353-061	19 mm	25 pcs	50 pcs
353-062	19.5 mm	25 pcs	50 pcs
353-063	20 mm	25 pcs	50 pcs
353-064	20.5 mm	1 pc	25 pcs
353-065	21 mm	1 pc	25 pcs
353-066	21.5 mm	1 pc	25 pcs
353-068	22.5 mm	1 pc	25 pcs
353-069	23 mm	1 pc	25 pcs
353-070	23.5 mm	1 pc	25 pcs
353-071	24 mm	1 pc	25 pcs
353-072	24.5 mm	1 pc	25 pcs
353-073	25 mm	1 pc	25 pcs
353-074	25.5 mm	1 pc	25 pcs
353-075	26 mm	1 pc	25 pcs
353-076	26.5 mm	1 pc	10 pcs
353-077	27 mm	1 pc	10 pcs
353-078	27.5 mm	1 pc	10 pcs
353-079	28 mm	1 pc	10 pcs
353-080	28.5 mm	1 pc	10 pcs
353-081	29 mm	1 pc	10 pcs
353-082	29.5 mm	1 pc	10 pcs
353-083	30 mm	1 pc	10 pcs

HSS material

C08 TWIST DRILL

MATA BOR BESI C08 - FOR STAINLESS



ITEM NO.	SIZE	BOX	CTN
353-301	1 mm	20 pcs	640 pcs
353-302	1,5 mm	20 pcs	640 pcs
353-303	2 mm	20 pcs	640 pcs
353-304	2,5 mm	20 pcs	640 pcs
353-305	3 mm	20 pcs	640 pcs
353-307	3,5 mm	20 pcs	320 pcs
353-308	4 mm	20 pcs	320 pcs
353-309	4,5 mm	20 pcs	320 pcs
353-311	5 mm	20 pcs	320 pcs
353-312	5,5 mm	20 pcs	320 pcs
353-313	6 mm	20 pcs	320 pcs
353-314	6,5 mm	10 pcs	320 pcs
353-315	7 mm	10 pcs	320 pcs
353-316	7,5 mm	10 pcs	320 pcs
353-317	8 mm	10 pcs	320 pcs
353-318	8,5 mm	10 pcs	320 pcs
353-319	9 mm	10 pcs	320 pcs
353-320	9,5 mm	10 pcs	320 pcs
353-321	10 mm	10 pcs	160 pcs
353-322	10,5 mm	10 pcs	160 pcs
353-323	11 mm	10 pcs	160 pcs
353-324	11,5 mm	10 pcs	160 pcs
353-325	12 mm	10 pcs	160 pcs
353-326	12,5 mm	10 pcs	160 pcs
353-327	13 mm	10 pcs	160 pcs

Cold stamped
DIN 338, material Co8

**H.S.S TWIST DRILLS****MATA BOR SET HSS**

ITEM NO.	SIZE	BOX	CTN
353-021	13 pcs (1,5-6,5mm)	20 sets	80 sets
	1.5, 2, 2.5, 3, 3.2, 3.5, 4, 4.5, 4.8, 5, 5.5, 6, 6.5		
353-022	19 pcs (1-10mm)	10 sets	40 sets
	1, 1.5, 2, 2.5, 3, 3.5, 4, 4.5, 5, 5.5, 6, 6.5, 7, 7.5, 8, 8.5, 9, 9.5, 10		
353-023	25 pcs (1-13 mm)	5 sets	20 sets
	1, 1.5, 2, 2.5, 3, 3.5, 4, 4.5, 5, 5.5, 6, 6.5, 7, 7.5, 8, 8.5, 9, 9.5, 10, 10.5, 11, 11.5, 12, 12.5, 13		

Chrome finished
HSS material

H.S.S TWIST DRILL**MATA BOR BESI H.S.S KHROM**

ITEM NO.	SIZE	BOX	CTN
353-351	1,0 mm	80 pcs	640 pcs
353-352	1,5 mm	80 pcs	640 pcs
353-353	2,0 mm	80 pcs	640 pcs
353-354	2,5 mm	80 pcs	640 pcs
353-355	3,0 mm	80 pcs	640 pcs
353-357	3,5 mm	40 pcs	320 pcs
353-358	4,0 mm	40 pcs	320 pcs
353-359	4,5 mm	40 pcs	320 pcs
353-361	5,0 mm	40 pcs	320 pcs
353-362	5,2 mm	40 pcs	320 pcs
353-363	5,5 mm	40 pcs	320 pcs
353-364	6,0 mm	40 pcs	320 pcs
353-365	6,5 mm	40 pcs	320 pcs
353-366	7,0 mm	40 pcs	320 pcs
353-367	7,5 mm	40 pcs	320 pcs
353-368	8,0 mm	40 pcs	320 pcs
353-369	8,5 mm	40 pcs	320 pcs
353-370	9,0 mm	40 pcs	320 pcs
353-371	9,5 mm	40 pcs	160 pcs
353-372	10,0 mm	40 pcs	160 pcs
353-373	10,5 mm	40 pcs	160 pcs
353-374	11,0 mm	40 pcs	160 pcs
353-375	11,5 mm	40 pcs	160 pcs
353-376	12,0 mm	40 pcs	160 pcs
353-377	12,5 mm	40 pcs	160 pcs
353-378	13,0 mm	40 pcs	160 pcs

Chrome finished
DIN 338, HSS material





POWER SAW BLADE
MATA GERGAJI MESIN

ITEM NO.	SIZE	BOX	CTN
364-023	14" x 10 T	10 pcs	200 pcs
364-024	16" x 10 T	10 pcs	150 pcs

High speed steel
Power saw blade



HACK SAW BLADE
MATA GERGAJI BESI ENGKEL

ITEM NO.	SIZE	BOX	CTN
364-026	12" x 24 T	100 pcs	1000 pcs

HSS Bi-metal
Shatterproof



SQUARE BLADE
PISAU BUBUT

ITEM NO.	SIZE	BOX	CTN
362-073	1/4" x 4	25 pcs	750 pcs
362-074	5/16" x 4	16 pcs	480 pcs
362-075	3/8" x 4	9 pcs	360 pcs
362-076	1/2" x 4	4 pcs	160 pcs
362-077	5/8" x 4	4 pcs	120 pcs
362-083	1/4" x 6	25 pcs	450 pcs
362-084	5/16" x 6	16 pcs	288 pcs
362-085	3/8" x 6	9 pcs	216 pcs
362-086	1/2" x 6	4 pcs	96 pcs
362-087	5/8" x 6	4 pcs	72 pcs

HSS material

10 PCS TCT ROTARY FILE SET
MATA BOR ROTARI TCT 10 PCS



ITEM NO.	SIZE	CTN
353-091	Shank 3 mm	25 sets
353-092	Shank 6 mm	25 sets

Tungsten carbide & tipped



SCREW EXTRACTOR SET

TAP BALIK

ITEM NO.	SIZE	BOX	CTN
399-002	6 pcs (1/8"-1/4", 1/4"-5/16", 5/16"-7/16", 7/16"-9/16" 9/16"-3/4", 3/4"-1")	20 sets	100 sets

High quality material
Used to open a broken bolt on the body material



PIPE EXTRACTOR

TAP BALIK KRAN AIR

ITEM NO.	SIZE	CTN
399-061	1/2", 3/4"	120 pcs

High carbon steel and bulk heat treatment

TAP & DIE SET 40 PCS



ITEM NO.	SIZE	BOX	CTN
399-003	17 Round Dies & 17 pcs Taps, each in Following size: 3 x 0,5 5 x 0,8 7 x 0,75 10 x 1,25 3 x 0,6 5 x 0,9 7 x 1,0 10 x 1,5 4 x 0,7 6 x 0,75 8 x 1,0 12 x 1,5 4 x 0,75 6 x 1,0 8 x 1,25 12 x 1,75 1/8 - 27 1 pc Die handle 1 pc Tap wrench 1 pc T type Tap wrench body 1 pc T type wrench sliding bar 1 pc Screw - Pitch Gauge 1 pc Screwdriver	1 set	10 sets

Alloy steel material

TAP & DIE SET 20 PCS



ITEM NO.	SIZE	BOX	CTN
399-004	9 pcs Round Dies & 9 pcs Taps, Each in Following size: 3 x 0,5 6 x 1,0 9 x 1,25 4 x 0,7 7 x 1,0 10 x 1,5 5 x 0,8 8 x 1,25 12 x 1,75 1 pc Die handle 1 pc Tap wrench	1 set	10 sets

Alloy steel material

TAP WRENCHES

STANG TAP



ITEM NO.	TYPE	BOX	CTN
399-007	M1-10	10 pcs	100 pcs
399-008	M4-12	10 pcs	40 pcs
399-009	M5-20	10 pcs	20 pcs

M1-10	M4-12	M5-20
⊕ 2.0 - 6.3 mm	⊕ 3.0 - 9.0 mm	⊕ 4.9 - 12.0 mm
BSW: 1/6"-3/8"	BSW: 5/32"-1/2"	BSW: 7/32"-3/4"
	BSP/G: 1/8"	BSP/G: 1/8"-1/2"

HAND TAP

HAND TAP 3 PCS

ITEM NO.	SIZE	CTN
399-011	3 mm x 0,5	360 sets
399-012	4 mm x 0,7	300 sets
399-013	5 mm x 0,8	300 sets
399-014	6 mm x 1,0	500 sets
399-015	7 mm x 1,0	125 sets
399-016	8 mm x 1,0	125 sets
399-017	8 mm x 1,25	125 sets
399-018	10 mm x 1,0	125 sets
399-019	10 mm x 1,25	125 sets
399-020	10 mm x 1,5	125 sets
399-021	12 mm x 1,25	80 sets
399-022	12 mm x 1,5	80 sets
399-023	12 mm x 1,75	80 sets
399-024	14 mm x 1,25	50 sets
399-025	14 mm x 1,5	50 sets
399-026	14 mm x 2,0	50 sets
399-027	16 mm x 1,25	50 sets
399-028	16 mm x 1,5	50 sets
399-029	16 mm x 2,0	50 sets
399-051	1/8" x 40	360 sets
399-052	3/16" x 24	300 sets
399-053	1/4" x 20	250 sets
399-054	5/16" x 18	250 sets
399-055	3/8" x 16	125 sets
399-056	1/2" x 12	80 sets
399-057	5/8" x 11	50 sets



Alloy steel material



GARDEN TOOL SET

ALAT KEBUN SET 5 PCS



ITEM NO.	SIZE	BOX	CTN
355-011	9 - 10"	20 sets	40 sets

Carbon steel tip with plastic handle

GARDEN TOOL SET

ALAT KEBUN SET 3 PCS



ITEM NO.	SIZE	BOX	CTN
355-012	9 - 10"	12 sets	48 sets

Plastic material

PRUNNING SHEAR

GUNTING DAHAN GAGANG KAYU



ITEM NO.	SIZE	BOX	CTN
362-033	8,5"	12 pcs	48 pcs

Carbon steel
Wooden handle

PRUNNING SHEAR

GUNTING DAHAN TYPE JAPAN



ITEM NO.	SIZE	BOX	CTN
362-036	8"	6 pcs	60 pcs

Carbon steel
Japan original standard



GRASS SCISSOR
GUNTING RUMPUT 3 POSISI

ITEM NO.	SIZE	CTN
362-151	330 mm	36 pcs

Sharper blade
360° rotation



FOLDING SAW
GERGAJI TANGKAI MODEL LIPAT

ITEM NO.	SIZE	BOX	CTN
363-001	7"	12 pcs	48 pcs

Comfortable rubber grip
Super sharp alloy steel three sections



PROFESSIONAL PRUNING SAW
GERGAJI DAHAN GAGANG ORANGE

ITEM NO.	SIZE	BOX	CTN
363-004	14"	6 pcs	48 pcs

HCS material, 7 TPI
Professional



TREETOP SHEAR
ALAT POTONG & GERGAJI BIJI COKLAT

ITEM NO.	BOX	CTN
388-101	10 pcs	20 pcs

Aluminum body in yellow color
Hardened steel blade



BRASS HEAD WATER SPRAYER

SEMPROTAN AIR KEPALA KUNINGAN



ITEM NO.	SIZE	BOX	CTN
378-001	3/4"	12 pcs	120 pcs

Adjustable spray pattern with lock clip for continuous spray
Zinc alloy body covered in rubber

RUBBER HEAD WATER SPRAYER

SEMPROTAN AIR KEPALA PVC



ITEM NO.	SIZE	BOX	CTN
378-002	3/4"	12 pcs	120 pcs

Adjustable spray pattern with lock clip for continuous spray
Zinc alloy body covered in rubber

PLASTIC WATER NOZZLE

SEMPROTAN AIR MODEL LURUS PLASTIK



ITEM NO.	SIZE	BOX	CTN
378-003	3/4"	25 pcs	200 pcs

Adjustable spray pattern



PLASTIC SOLID SPRAY GUN

SEMPROTAN AIR 7 POSISI

ITEM NO.	SIZE	BOX	CTN
378-004	3/4"	20 pcs	60 pcs

Adjustable spray pattern
Strong PVC body with rubber grip



LONG TYPE SPRAY GUN

SEMPROTAN AIR GAGANG PANJANG

ITEM NO.	SIZE	BOX	CTN
378-007	45 cm	6 pcs	36 pcs

9 patterns



5 PCS BASIC HOSE SET

SEMPROTAN AIR 5 IN 1

ITEM NO.	SIZE	BOX	CTN
378-008	1/2"	10 pcs	50 pcs

2 patterns



5 PCS BASIC HOSE SET

SEMPROTAN AIR 7 POSISI SET (5 PCS)

ITEM NO.	SIZE	BOX	CTN
378-009	1/2"	10 pcs	50 pcs

Adjustable spray pattern
7 patterns



PLASTIC SOLID SPRAY GUN

SEMPROTAN AIR 2 IN 1

ITEM NO.	SIZE	BOX	CTN
378-014	3/4"	10 pcs	120 pcs

Strong PVC body in black color

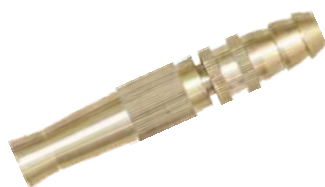

BRASS WATER NOZZLE

SEMPROTAN AIR KUNINGAN

ITEM NO.	SIZE	BOX	CTN
378-006	4"	12 pcs	240 pcs

Full solid brass



BRASS WATER NOZZLE

SEMPROTAN AIR KUNINGAN BODY KARET

ITEM NO.	SIZE	BOX	CTN
378-015	4"	12 pcs	240 pcs

Solid Brass with rubber handle



PLASTIC ADJUSTABLE SPRAY GUN

SEMPROTAN AIR MODEL PISTOL

ITEM NO.	SIZE	BOX	CTN
378-038	3/4"	10 pcs	60 pcs

Strong ABS material



ROTATING WATER SPRAYER
SPRINKLE TAMAN 3 CABANG

ITEM NO.	SIZE	BOX	CTN
378-021	3/4"	1 pc	60 pcs

Revolving arms for equalizing sprinkle



PLASTIC ROTATING WATER SPRAYER
SPRINKLE TAMAN PVC 3 CABANG

ITEM NO.	SIZE	BOX	CTN
378-022	3/4"	10 pcs	80 pcs

Strong ABS material in yellow color



PLASTIC SPRINKLER
SPRINKLE TAMAN PULSE

ITEM NO.	SIZE	BOX	CTN
378-029	4"	50 pcs	400 pcs

Specification:

Working pressure	1,5 - 3.0 bar
Flow	0,8 - 1.2 m ³ /h
Spraying Radius	8-12 m
Connecting Size	1/2" male thread



PLASTIC SPRAYER SPRAYER PLASTIK

ITEM NO.	SIZE	CTN
378-025	1,5 ltr	20 pcs
378-026	2 ltr	20 pcs

Adjustable with key lock
Cooling System Purpose
For Watering Tree
Plastic material
Brass tip



PLASTIC SPRAYER SPRAYER PLASTIK

ITEM NO.	SIZE	CTN
378-027	5 ltr	6 pcs

Hose length: 110cm, Weight: 668g
Type: D8700



KNIFE FOR RUBBER PLANT PISAU SADAP KARET

ITEM NO.	SIZE	BOX	CTN
362-059	23 cm	12 pcs	120 pcs

Sharp and strong steel plate material
Wooden handle



COPPER PIPE BENDER

ALAT PEMBENGGOK PIPA TEMBAGA 3 IN 1

ITEM NO.	SIZE	BOX	CTN
347-114	1/4" - 5/16" - 3/8"	1 pc	20 pcs

High precision
Aluminum material



PIPE CUTTER

ALAT POTONG PIPA TEMBAGA

ITEM NO.	SIZE	BOX	CTN
362-041	3 - 32 mm	10 pcs	50 pcs

Heavy duty professional tool

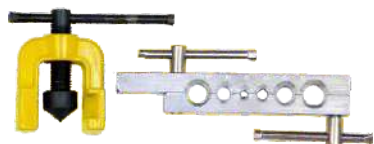

FLARING TOOLS

ALAT PEMEKAR PIPA TEMBAGA

ITEM NO.	SIZE	BOX	CTN
362-051	Flaring Tools 3/16", 1/4", 5/16" 3/8", 7/16", 1/2", 5/8"	6 sets	36 sets

High precision tool



FLARING TOOLS SET

ALAT POTONG & PEMEKAR PIPA TEMBAGA SET

ITEM NO.	SIZE	CTN
362-054	Tube Cutter 1/8"-1 1/8" Flaring Tools 3/16", 1/4", 5/16" 3/8", 7/16", 1/2", 5/8"	10 sets

For expanding tube

**10 PCS NEEDLE FILE SET****KIKIR EMAS SET 10 PCS**

ITEM NO.	SIZE	BOX	CTN
352-001	3" x 140 mm hand file	10 sets	100 sets
	3" x 140 mm half round file		
	3" x 140 mm three square file		
	3" x 140 mm square file		
	3" x 140 mm round file		
	3" x 140 mm warding file		
	3" x 140 mm knife file		
	3" x 140 mm barrette file		
	3" x 140 mm crossing file		
	3" x 140 mm ovel file		

File with many shapes used to carefully process different shapes
Comfortable rubber grip

7 PCS FILE SET**KIKIR SET 7 PCS**

ITEM NO.	SIZE	BOX	CTN
352-002	8" mill bastard file	5 sets	20 sets
	8" half round wood rasp file		
	6" bastard file		
	6" round bastard file		
	6" half round file		
	6" slim taper file		
	Handle fits all sizes		

Various surfaces and forms in accordance with the file purposes
Comfortable rubber grip

CHAINSAW FILE**KIKIR CHAINSAW**

ITEM NO.	SIZE	BOX	CTN
352-004	8" x 4,8 mm	1 dzn	50 dzn
352-003	8" x 5,5 mm	1 dzn	50 dzn

High quality material



FLAT FILE

KIKIR PLAT KASAR

ITEM NO.	SIZE	BOX	CTN
352-006	8"	10 pcs	60 pcs
352-007	10"	10 pcs	40 pcs
352-008	12"	12 pcs	48 pcs

Tapered in width and thickness
Double cut on both sides and single cut on eagles
Comfortable rubber grip
For steel



SLIM TAPER FILE

KIKIR SEGITIGA

ITEM NO.	SIZE	BOX	CTN
352-012	3"	1 dzn	10 dzn
352-013	4"	1 dzn	10 dzn
352-014	5"	1 dzn	10 dzn
352-015	6"	1 dzn	10 dzn

For filing all types of saws with angle teeth
single cut edges set and cut for filing guilets between saw teeth
Comfortable rubber grip
For steel



HALF ROUND STEEL FILE

KIKIR SETENGAH BULAT KASAR

ITEM NO.	SIZE	BOX	CTN
352-026	8"	10 pcs	60 pcs
352-027	10"	10 pcs	40 pcs

The half round side (front), ideal for getting into rounded hole
Comfortable rubber grip



ROUND STEEL FILE

KIKIR BULAT KASAR

ITEM NO.	SIZE	BOX	CTN
352-036	8"	10 pcs	60 pcs
352-037	10"	10 pcs	40 pcs

Shape tapers slightly toward point
Comfortable rubber grip



6 PCS DIAMOND HAND FILE SET

KIKIR DIAMOND 6 PCS



ITEM NO.	SIZE	BOX	CTN
352-038	3" x 140 x 70 mm	10 sets	200 sets

Form files with multifunctional use
Comfortable rubber grip
Coated with diamond

5 PCS DIAMOND HAND FILE SET

KIKIR DIAMOND 5 PCS



ITEM NO.	SIZE	BOX	CTN
352-039	3" x 140 x 70 mm	10 sets	200 sets

Coated with diamond

HALF ROUND WOOD RASP

KIKIR KAYU SETENGAH BULAT



ITEM NO.	SIZE	BOX	CTN
352-046	8"	10 pcs	60 pcs
352-047	10"	10 pcs	40 pcs
352-048	12"	6 pcs	36 pcs

Comfortable rubber grip
For wood



ADJUSTABLE WRENCH

KUNCI BACO SATIN

ITEM NO.	SIZE	BOX	CTN
346-162	8"	6 pcs	96 pcs
346-163	10"	6 pcs	48 pcs
346-164	12"	6 pcs	36 pcs
346-165	15"	6 pcs	12 pcs

Chrome vanadium in satin finished



ADJUSTABLE WRENCH

KUNCI BACO KHROM

ITEM NO.	SIZE	BOX	CTN	
346-206	10"	6 pcs	60 pcs	Rp 115.000/pc
346-207	12"	6 pcs	36 pcs	Rp 145.000/pc
346-208	15"	6 pcs	24 pcs	Rp 310.000/pc
346-160	18"	1 pc	12 pcs	

Chrome vanadium material



ADJUSTABLE WRENCH

KUNCI BACO SATIN GG KUNING HITAM

ITEM NO.	SIZE	BOX	CTN
346-274	8"	6 pcs	60 pcs

Chrome vanadium with rubber handle



PIPE WRENCH

KUNCI PIPA

ITEM NO.	SIZE	BOX	CTN
346-251	10"	12 pcs	48 pcs
346-252	12"	9 pcs	36 pcs
346-253	14"	6 pcs	24 pcs
346-254	18"	1 pc	12 pcs
346-255	24"	1 pc	10 pcs
346-256	36"	1 pc	6 pcs

Heavy duty
With rubber grip handle

RATCHET WRENCH

KUNCI DOUBLE RATCHET CR-V HITAM



ITEM NO.	SIZE	BOX	CTN
346-480	10 x 12 mm	2 pcs	100 pcs
346-481	11 x 13 mm	2 pcs	100 pcs
346-482	12 x 14 mm	2 pcs	100 pcs
346-483	14 x 17 mm	2 pcs	50 pcs

Alloy steel material

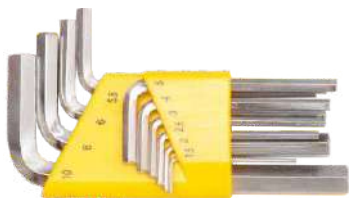

10 PCS HEX KEY

KUNCI L CR-V 10 PCS

ITEM NO.	SIZE	BOX	CTN
346-171	1.5, 2, 2.5, 3, 4, 5 5.5, 6, 8, 10 mm	10 sets	100 sets
346-172	1/16", 5/64", 3/32", 1/8", 5/32", 3/16", 7/32", 1/4", 5/16", 3/8"	10 sets	100 sets

Solid steel tempered & polished



9 PCS LONG BALLPOINT HEX KEY

KUNCI L BALLPOINT PANJANG 9 PCS

ITEM NO.	SIZE	BOX	CTN
346-173	1.5, 2, 2.5, 3, 4, 5, 6, 8, 10 mm	10 sets	40 sets

Solid steel tempered & polished

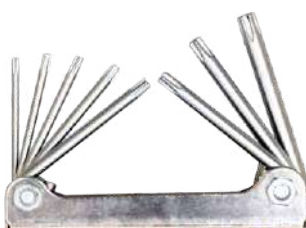

8 PCS FOLDING TORX KEY

KUNCI L LIPAT BINTANG 8 PCS

ITEM NO.	SIZE	BOX	CTN
346-175	T-9, T-10, T-15, T-20, T-25, T-27, T-30, T-40	10 sets	50 sets

Chrome plated handle



9 PCS BALL POINT HEX KEY

KUNCI L BALLPOINT EXTRA LONG 9 PCS

ITEM NO.	SIZE	BOX	CTN
346-176	1.5, 2, 2.5, 3, 4, 5, 6, 8, 10 mm	12 sets	48 sets

Chrome vanadium material



10 PCS HEX KEY

KUNCI L HITAM 10 PCS



ITEM NO.	SIZE	BOX	CTN
346-182	1.5, 2, 2.5, 3, 4, 5, 5.5, 6, 8, 10 mm	12 sets	120 sets

Solid steel tempered & black finished

9 PCS LONG TYPE TORX KEY

KUNCI L BINTANG LONG 9 PCS



ITEM NO.	SIZE	BOX	CTN
346-187	T10, T15, T20, T25 T27, T30, T40, T45, T50	10 sets	60 sets

Solid steel tempered & polished

9 PCS COMBINATION KEY SET

KUNCI L KOMBINASI SATIN 9 PCS



ITEM NO.	SIZE	BOX	CTN
346-321	Hex 1.5, 2, 2.5, 3, 4, 5 6, 8, 10 mm Torx T15, T20, T27, T40, T45, T50, T55	10 sets	60 sets

Solid steel tempered & polished



HEX KEY
KUNCI L CR-V BINTANG

ITEM NO.	SIZE	BOX	CTN
346-157	T45	25 pcs	250 pcs
346-158	T50	20 pcs	200 pcs

Chrome vanadium material in satin finished



HEX KEY
KUNCI L CR-V

ITEM NO.	SIZE	BOX	CTN
346-178	5 pcs x 6 mm	12 sets	120 sets

Chrome vanadium material in colorful coating



T HANDLE HEX KEY

KUNCI L GAGANG T CR-V

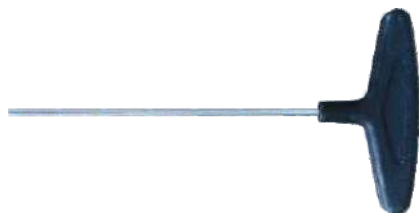

ITEM NO.	SIZE	BOX	CTN
346-231	T 2,5	10 pcs	60 pcs
346-232	T 3	10 pcs	60 pcs
346-235	T 6	10 pcs	60 pcs
346-236	T 8	10 pcs	60 pcs
346-237	T 10	10 pcs	60 pcs

Chrome vanadium with rubber handle

HEX KEY CHROME

KUNCI L SATIN KHROM CR-V



ITEM NO.	SIZE	BOX	CTN
346-330	1,5 mm	100 pcs	2000 pcs
346-331	2 mm	100 pcs	2000 pcs
346-332	2,5 mm	100 pcs	2000 pcs
346-333	3 mm	100 pcs	2000 pcs
346-334	4 mm	75 pcs	750 pcs
346-335	5 mm	50 pcs	600 pcs
346-336	6 mm	50 pcs	300 pcs
346-337	8 mm	25 pcs	200 pcs
346-338	10 mm	20 pcs	200 pcs
346-339	12 mm	10 pcs	60 pcs
346-340	14 mm	5 pcs	40 pcs

Standard Hex key
Chrome vanadium material



DOUBLE OPEN ENDED SPANNER

KUNCI PAS SATIN CR-V

ITEM NO.	SIZE	BOX	CTN
346-008	14 x 15 mm	12 pcs	240 pcs
346-010	16 x 17 mm	12 pcs	180 pcs
346-012	18 x 19 mm	12 pcs	180 pcs
346-013	20 x 22 mm	6 pcs	120 pcs
346-014	21 x 23 mm	6 pcs	120 pcs
346-015	24 x 27 mm	6 pcs	60 pcs
346-016	25 x 28 mm	6 pcs	48 pcs
346-017	30 x 32 mm	6 pcs	48 pcs

Chrome vanadium in satin finished
Metric size

DOUBLE OPEN SPANNER SET

KUNCI PAS SATIN CR-V SET



ITEM NO.	SIZE	BOX	CTN
346-072	8 pcs (6 - 22 mm)	1 set	20 sets
	6 x 7 12 x 13 18 x 19		
	8 x 9 14 x 15 20 x 22		
	10 x 11 16 x 17 mm		

Chrome vanadium in satin finished
Metric size

DOUBLE OPEN SPANNER SET

KUNCI PAS SATIN CR-V SET



ITEM NO.	SIZE	BOX	CTN
346-073	12 pcs (6 - 32 mm)	1 set	10 sets
	6 x 7 14 x 15 21 x 23		
	8 x 9 16 x 17 24 x 27		
	10 x 11 18 x 19 25 x 28		
	12 x 13 20 x 22 30 x 32 mm		

Chrome vanadium in satin finished
Metric size



FLARE NUT SPANNER

KUNCI NEPEL



ITEM NO.	SIZE	BOX	CTN
346-713	12 x 14 mm	10 pcs	200 pcs

Plastic hanger
Mirror polished

RING SPANNER

KUNCI RING SATIN CR-V



ITEM NO.	SIZE	BOX	CTN
346-028	14 x 15 mm	6 pcs	150 pcs
346-030	16 x 17 mm	6 pcs	150 pcs
346-036	25 x 28 mm	6 pcs	30 pcs
346-037	30 x 32 mm	6 pcs	30 pcs

Chrome vanadium in satin finished
Metric size



COMBINATION SPANNER

KUNCI RING PAS SATIN CR-V MM

ITEM NO.	SIZE	BOX	CTN
346-041	8 mm	12 pcs	360 pcs
346-042	9 mm	12 pcs	360 pcs
346-044	11 mm	12 pcs	300 pcs
346-049	16 mm	12 pcs	180 pcs
346-053	20 mm	6 pcs	120 pcs
346-054	21 mm	6 pcs	90 pcs
346-055	22 mm	6 pcs	90 pcs
346-600	33 mm	5 pcs	20 pcs
346-601	34 mm	5 pcs	20 pcs
346-602	35 mm	5 pcs	20 pcs
346-605	41 mm	4 pcs	16 pcs
346-606	46 mm	3 pcs	12 pcs
346-607	50 mm	2 pcs	8 pcs

Chrome vanadium in satin finished
Metric size



COMBINATION SPANNER

KUNCI RING PAS SATIN CR-V INCH

ITEM NO.	SIZE	BOX	CTN
346-621	5/16"	10 pcs	600 pcs
346-622	3/8"	10 pcs	400 pcs
346-623	7/16"	10 pcs	300 pcs
346-624	1/2"	10 pcs	300 pcs
346-625	9/16"	10 pcs	200 pcs
346-626	5/8"	10 pcs	200 pcs
346-627	11/16"	10 pcs	200 pcs
346-628	3/4"	10 pcs	100 pcs
346-629	13/16"	10 pcs	100 pcs
346-630	7/8"	10 pcs	100 pcs
346-631	15/16"	10 pcs	60 pcs
346-632	1"	10 pcs	60 pcs
346-633	1 1/6"	10 pcs	60 pcs
346-634	1 1/8"	10 pcs	40 pcs
346-635	1 1/4"	10 pcs	40 pcs

Chrome vanadium in satin finished
Inch size

**DOUBLE OPEN ENDED SPANNER****KUNCI PAS CR-V HITAM**

ITEM NO.	SIZE	BOX	CTN
346-513	20 x 22 mm	12 pcs	120 pcs
346-515	24 x 27 mm	6 pcs	60 pcs
346-516	25 x 28 mm	6 pcs	48 pcs
346-517	30 x 32 mm	6 pcs	48 pcs

Chrome vanadium in black finished
Metric size

**RING SPANNER****KUNCI RING CR-V HITAM**

ITEM NO.	SIZE	BOX	CTN
346-533	20 x 22 mm	6 pcs	90 pcs
346-534	21 x 23 mm	6 pcs	60 pcs
346-535	24 x 27 mm	6 pcs	60 pcs
346-536	25 x 28 mm	6 pcs	30 pcs
346-537	30 x 32 mm	6 pcs	30 pcs

Heavy duty chrome vanadium in black finished

**COMBINATION SPANNER****KUNCI RING PAS CR-V HITAM**

ITEM NO.	SIZE	BOX	CTN
346-549	16 mm	12 pcs	180 pcs
346-553	20 mm	6 pcs	120 pcs
346-554	21 mm	6 pcs	90 pcs
346-555	22 mm	6 pcs	90 pcs
346-564	28 mm	6 pcs	60 pcs

Heavy duty chrome vanadium in black finished



DOUBLE OPEN ENDED SPANNER

KUNCI PAS KHROM

ITEM NO.	SIZE	BOX	CTN
346-722	8 x 9 mm	5 pcs	360 pcs
346-723	8 x 10 mm	5 pcs	360 pcs
346-724	10 x 11 mm	5 pcs	360 pcs
346-725	10 x 12 mm	5 pcs	360 pcs
346-726	12 x 13 mm	5 pcs	300 pcs
346-727	12 x 14 mm	5 pcs	300 pcs
346-728	14 x 15 mm	5 pcs	240 pcs
346-729	14 x 17 mm	5 pcs	180 pcs
346-730	16 x 17 mm	5 pcs	180 pcs
346-731	17 x 19 mm	5 pcs	180 pcs
346-732	18 x 19 mm	5 pcs	180 pcs
346-733	20 x 22 mm	5 pcs	120 pcs
346-734	21 x 23 mm	5 pcs	120 pcs
346-735	24 x 27 mm	5 pcs	60 pcs
346-736	25 x 28 mm	5 pcs	50 pcs
346-737	30 x 32 mm	5 pcs	50 pcs

Chrome vanadium in satin finished
Metric size

DOUBLE OPEN SPANNER SET

KUNCI PAS KHROM SET



ITEM NO.	SIZE	BOX	CTN
346-738	8 pcs (6 - 24 mm)	1 set	20 sets
	6 x 7 mm	14 x 15 mm	
	8 x 9 mm	16 x 17 mm	
	10 x 11 mm	19 x 21 mm	
	12 x 13 mm	22 x 24 mm	

Chrome vanadium in satin finished
Metric size

DOUBLE OPEN SPANNER SET

KUNCI PAS KHROM SET



ITEM NO.	SIZE	BOX	CTN
346-739	12 pcs (6 - 32 mm)	1 set	6 sets
	6 x 7 mm	18 x 19 mm	
	8 x 9 mm	20 x 22 mm	
	10 x 11 mm	21 x 23 mm	
	12 x 13 mm	24 x 27 mm	
	14 x 15 mm	25 x 28 mm	
	16 x 17 mm	30 x 32 mm	

Chrome vanadium in satin finished
Metric size



RING SPANNER KUNCI RING KHROM



ITEM NO.	SIZE	BOX	CTN
346-771	6 x 7 mm	5 pcs	240 pcs
346-772	8 x 9 mm	5 pcs	240 pcs
346-773	8 x 10 mm	5 pcs	240 pcs
346-774	10 x 11 mm	5 pcs	240 pcs
346-775	10 x 12 mm	5 pcs	240 pcs
346-776	12 x 13 mm	5 pcs	240 pcs
346-777	12 x 14 mm	5 pcs	240 pcs
346-778	14 x 15 mm	5 pcs	150 pcs
346-779	14 x 17 mm	5 pcs	150 pcs
346-780	16 x 17 mm	5 pcs	150 pcs
346-781	17 x 19 mm	5 pcs	120 pcs
346-782	18 x 19 mm	5 pcs	120 pcs
346-783	20 x 22 mm	5 pcs	90 pcs
346-784	21 x 23 mm	5 pcs	60 pcs
346-785	24 x 27 mm	5 pcs	30 pcs
346-786	25 x 28 mm	5 pcs	30 pcs
346-787	30 x 32 mm	5 pcs	30 pcs

Chrome vanadium in satin finished
Metric size

DOUBLE OFFSET RING SPANNER SET KUNCI RING KHROM SET



ITEM NO.	SIZE	BOX	CTN
346-789	8 pcs (6 - 24 mm)	1 set	20 sets
	6 x 7 mm 14 x 15 mm		
	8 x 9 mm 16 x 17 mm		
	10 x 11 mm 18 x 19 mm		
	12 x 13 mm 22 x 24 mm		

Chrome vanadium in satin finished
Metric size

DOUBLE OFFSET RING SPANNER SET KUNCI RING KHROM SET



ITEM NO.	SIZE	BOX	CTN
346-790	12 pcs (6 - 32mm)	1 set	6 sets
	6 x 7 mm 18 x 19 mm		
	8 x 9 mm 20 x 22 mm		
	10 x 11 mm 21 x 23 mm		
	12 x 13 mm 24 x 27 mm		
	14 x 15 mm 25 x 28 mm		
	16 x 17 mm 30 x 32 mm		

Chrome vanadium in satin finished
Metric size

COMBINATION SPANNER
KUNCI RING PAS KHROM



ITEM NO.	SIZE	BOX	CTN
346-742	8 mm	5 pcs	360 pcs
346-743	9 mm	5 pcs	360 pcs
346-744	10 mm	5 pcs	360 pcs
346-745	11 mm	5 pcs	300 pcs
346-746	12 mm	5 pcs	300 pcs
346-747	13 mm	5 pcs	240 pcs
346-748	14 mm	5 pcs	240 pcs
346-749	15 mm	5 pcs	180 pcs
346-750	16 mm	5 pcs	180 pcs
346-751	17 mm	5 pcs	120 pcs
346-752	19 mm	5 pcs	120 pcs
346-753	20 mm	5 pcs	120 pcs
346-754	21 mm	5 pcs	90 pcs
346-755	22 mm	5 pcs	90 pcs
346-756	24 mm	5 pcs	60 pcs
346-758	27 mm	5 pcs	60 pcs
346-759	28 mm	5 pcs	30 pcs
346-760	30 mm	5 pcs	30 pcs
346-761	32 mm	5 pcs	30 pcs
346-762	33 mm	2 pcs	20 pcs
346-763	34 mm	2 pcs	20 pcs
346-764	35 mm	2 pcs	20 pcs
346-765	36 mm	2 pcs	12 pcs
346-766	38 mm	2 pcs	12 pcs
346-791	41 mm	2 pcs	12 pcs
346-792	42 mm	2 pcs	12 pcs
346-793	46 mm	2 pcs	12 pcs
346-794	50 mm	2 pcs	8 pcs

Chrome vanadium in satin finished
Metric size



COMBINATION SPANNER SET
KUNCI RING PAS KHROM SET

ITEM NO.	SIZE	BOX	CTN
346-767	11 pcs (8 - 24 mm) 8, 9, 10, 11, 12, 13, 14, 17, 19, 22, 24 mm	1 set	10 sets

Chrome vanadium in satin finished
Metric size



COMBINATION SPANNER SET
KUNCI RING PAS KHROM SET

ITEM NO.	SIZE	BOX	CTN
346-768	14 pcs (8 - 24 mm) 8, 9, 10, 11, 12, 13, 14, 15, 16, 17, 19, 21, 22, 24 mm	1 set	10 sets

Chrome vanadium in satin finished
Metric size



COMBINATION SPANNER SET
KUNCI RING PAS KHROM SET

ITEM NO.	SIZE	BOX	CTN
346-769	14 pcs (8 - 32 mm) 8, 10, 11, 12, 13, 14, 16, 17, 19, 21, 24, 27, 30, 32 mm	1 set	6 sets

Chrome vanadium in satin finished
Metric size



HALF MOON RING SPANNER
KUNCI RING BULAN SATIN CR-V

ITEM NO.	SIZE	BOX	CTN
346-076	10 x 12 mm	100 pcs	400 pcs
346-077	11 x 13 mm	100 pcs	400 pcs
346-078	14 x 17 mm	50 pcs	200 pcs
346-079	16 x 18 mm	30 pcs	120 pcs

Chrome vanadium in satin finished
Metric size



TOREX SPANNERS SET
KUNCI RING BINTANG SATIN CR-V 4PCS

ITEM NO.	SIZE	BOX	CTN
346-091	4 pcs E 6 x E 8 mm E 10 x E 12 mm E 14 x E 18 mm E 20 x E 24 mm	1 set	40 sets

Chrome vanadium in satin finished
Metric size



RATCHET COMBINATION SPANNER
KUNCI RING PAS RATCHET SATIN

ITEM NO.	SIZE	BOX	CTN
346-643	10 mm	10 pcs	300 pcs
346-644	11 mm	10 pcs	300 pcs

Cold stamped in satin finished
Ratchet system for convenient use



MULTI SOCKET WRENCH

KUNCI SOK ROTARI 8 IN 1



ITEM NO.	SIZE	BOX	CTN
346-140	8, 10, 12,13 14, 17, 19, 21 mm	12 pcs	24 pcs

2 PCS MULTIPURPOSE WRENCH

KUNCI PAS SERBAGUNA 2 PCS



ITEM NO.	SIZE	BOX	CTN
346-740	9 - 22 mm 9 - 32 mm	10 sets	40 sets

Used for: plumbing, vehicle, bicycle, electrical maintenance

CR-MO STEEL T-SLIDING HAND BAR

SLIDING T HITAM CR-MO



ITEM NO.	SIZE	CTN
346-309	3/4"	10 pcs

Heavy duty
Black finished

CR-MO STEEL IMPACT SOCKET

KUNCI SOK IMPACT HITAM



ITEM NO.	SIZE	CTN
346-801	22 mm x 3/4" DR	20 pcs
346-802	23 mm x 3/4" DR	20 pcs
346-805	28 mm x 3/4" DR	20 pcs
346-808	33 mm x 3/4" DR	20 pcs
346-809	34 mm x 3/4" DR	20 pcs
346-810	35 mm x 3/4" DR	20 pcs
346-812	38 mm x 3/4" DR	20 pcs
346-813	41 mm x 3/4" DR	20 pcs
346-814	42 mm x 3/4" DR	20 pcs
346-815	45 mm x 3/4" DR	16 pcs
346-817	48 mm x 3/4" DR	9 pcs
346-818	50 mm x 3/4" DR	9 pcs
346-821	22 mm x 1" DR	20 pcs
346-822	23 mm x 1" DR	20 pcs
346-823	24 mm x 1" DR	20 pcs
346-825	28 mm x 1" DR	20 pcs
346-826	30 mm x 1" DR	20 pcs
346-829	34 mm x 1" DR	20 pcs
346-830	35 mm x 1" DR	20 pcs
346-831	36 mm x 1" DR	20 pcs
346-832	38 mm x 1" DR	20 pcs
346-834	42 mm x 1" DR	16 pcs
346-835	45 mm x 1" DR	16 pcs
346-836	46 mm x 1" DR	16 pcs
346-837	48 mm x 1" DR	9 pcs
346-838	50 mm x 1" DR	9 pcs

Heavy duty
Black finished

CR-MO STEEL IMPACT SOCKET ADAPTOR

KUNCI SOK IMPACT ADAPTOR CR-MO



ITEM NO.	SIZE	CTN
346-841	1/2" F x 3/4" M	20 pcs
346-842	3/4" F x 1/2" M	20 pcs
346-843	3/4" F x 1" M	20 pcs

Heavy duty
Black finished



9 PCS 1/2 " DR. SOCKET SET

KUNCI SOK SET



ITEM NO.	SIZE	BOX	CTN
346-401	1/2" DR L Bar 10, 11, 12 13, 14, 17 19, 22 mm	1 set	12 sets

Super luck socket 6 pt
1/2" DR. Chrome vanadium

10 PCS 1/2 " DR. SOCKET SET

KUNCI SOK SET



ITEM NO.	SIZE	BOX	CTN
346-402	1/2" DR L Bar 10, 11, 12 13, 14, 17 19, 22, 24 mm	1 set	12 sets

Super luck socket 6 pt
1/2" DR. Chrome vanadium

25 PCS 1/2 " DR. SOCKET SET

KUNCI SOK SET



ITEM NO.	SIZE	BOX	CTN
346-403	18 pcs 1/2" DR. Socket: 10, 11, 12, 13, 14, 15, 16, 17, 18, 19, 20, 21, 22, 23, 24, 27, 30, 32 mm 2 pcs 1/2" DR. Spark plug Socket 2 pcs extension bar 5" & 10" 1 pc quick release ratchet handle 1 pc sliding T bar 10" 1 pc universal joint	1 set	4 sets

Super luck socket 6 pt
1/2" DR. Chrome vanadium

SOCKET

KUNCI SOK 6 POINT



ITEM NO.	SIZE	BOX	CTN
346-452	8 mm	10 pcs	200 pcs
346-453	9 mm	10 pcs	200 pcs
346-454	10 mm	10 pcs	200 pcs
346-455	11 mm	10 pcs	200 pcs
346-456	12 mm	10 pcs	200 pcs
346-457	13 mm	10 pcs	200 pcs
346-458	14 mm	10 pcs	200 pcs
346-459	15 mm	10 pcs	200 pcs
346-460	16 mm	10 pcs	200 pcs
346-461	17 mm	10 pcs	200 pcs
346-462	18 mm	10 pcs	200 pcs
346-463	19 mm	10 pcs	200 pcs
346-464	20 mm	10 pcs	200 pcs
346-465	21 mm	10 pcs	200 pcs
346-466	22 mm	10 pcs	200 pcs
346-467	23 mm	10 pcs	200 pcs
346-468	24 mm	10 pcs	200 pcs
346-469	27 mm	10 pcs	120 pcs
346-470	30 mm	10 pcs	120 pcs
346-471	32 mm	10 pcs	120 pcs

Super luck socket 6 point
1/2" DR. Chrome vanadium

SOCKET

KUNCI SOK 12 POINT



ITEM NO.	SIZE	BOX	CTN
346-660	8 mm	12 pcs	48 pcs
346-661	9 mm	12 pcs	48 pcs
346-662	10 mm	12 pcs	48 pcs
346-663	11 mm	12 pcs	48 pcs
346-664	12 mm	12 pcs	48 pcs
346-665	13 mm	12 pcs	48 pcs
346-666	14 mm	12 pcs	48 pcs
346-667	15 mm	12 pcs	48 pcs
346-668	16 mm	12 pcs	48 pcs
346-669	17 mm	12 pcs	48 pcs
346-670	18 mm	12 pcs	48 pcs
346-671	19 mm	12 pcs	48 pcs
346-672	20 mm	12 pcs	48 pcs
346-673	21 mm	12 pcs	48 pcs
346-674	22 mm	12 pcs	48 pcs
346-675	23 mm	12 pcs	48 pcs
346-676	24 mm	12 pcs	48 pcs
346-677	27 mm	12 pcs	48 pcs
346-678	30 mm	12 pcs	48 pcs
346-679	32 mm	12 pcs	48 pcs

Socket 12 point
1/2" DR. Chrome vanadium



CR-V STEEL "L" HANDLE

STANG SOK L SATIN CR-V



ITEM NO.	SIZE	BOX	CTN
346-302	1/2" x 250 mm	10 pcs	60 pcs

Chrome vanadium material
Satin finished

CR-V STEEL SLIDING BAR

SLIDING T SATIN CR-V



ITEM NO.	SIZE	BOX	CTN
346-303	1/2" x 250 mm	10 pcs	60 pcs

Chrome vanadium material
Satin finished

CR-V STEEL JOINT BAR

EXTENSION BAR SATIN CR-V



ITEM NO.	SIZE	BOX	CTN
346-304	1/2" x 75 mm	10 pcs	120 pcs
346-305	1/2" x 125 mm	10 pcs	100 pcs
346-306	1/2" x 250 mm	10 pcs	60 pcs

Chrome vanadium material
Satin finished

RAPID RATCHET HANDLE

STANG SOK RATCHET SATIN CR-V



ITEM NO.	SIZE	CTN
346-308	1/2" x 260 mm	40 pcs

Chrome vanadium material
Mirror polished



SPARK PLUG WRENCH
KUNCI BUSI FLEKSIBEL

ITEM NO.	SIZE	BOX	CTN
346-196	16 mm	10 pcs	50 pcs
346-197	21 mm	10 pcs	50 pcs

Flexible universal joint
Chrome plated steel socket



CR-V SPARK PLUG SOCKET
KUNCI SOK BUSI CR-V

ITEM NO.	SIZE	BOX	CTN
346-198	1/2" x 16 mm	10 pcs	120 pcs
346-199	1/2" x 21 mm	10 pcs	100 pcs

Chrome vanadium material
Satin finished



RATCHET SOCKET TOOLS SET
KUNCI SOK 8 PCS

ITEM NO.	SIZE	BOX	CTN
346-404	3/8" (8 - 19 mm)	6 sets	12 sets

Chrome vanadium
Quick released push
Full covered plastic grip with ergonomic design



RATCHET SOCKET TOOLS SET
KUNCI SOK 8 PCS

ITEM NO.	SIZE	BOX	CTN
346-405	1/2" (10 - 19 mm)	6 sets	12 sets

Chrome vanadium
Quick released push
Full covered plastic grip with ergonomic design



CROSS RIM WRENCH

KUNCI RODA PALANG UNGU METALIK

ITEM NO.	SIZE	CTN
346-211	15" x 15mm	12 pcs

Chrome vanadium
17, 19, 21 & 23 mm socket size



CROSS RIM WRENCH

KUNCI RODA PALANG BIRU METALIK

ITEM NO.	SIZE	CTN
346-212	14" x 15mm	12 pcs

Chrome vanadium
17, 19, 21 & 23 mm socket size



CROSS RIM WRENCH

KUNCI RODA PALANG KHROM GAGANG KARET

ITEM NO.	SIZE	CTN
346-213	14"	12 pcs

Chrome vanadium
17, 19, 21 & 23 mm socket size



DOUBLE SOCKET WRENCH

KUNCI SOK MODEL L

ITEM NO.	SIZE	BOX	CTN
346-100	17 mm	10 pcs	80 pcs
346-101	19 mm	10 pcs	70 pcs
346-103	23 mm	10 pcs	40 pcs

Heavy duty steel construction



EXTENSION L TYPE WRENCH

KUNCI RODA L

ITEM NO.	SIZE	BOX	CTN
346-201	1/2" x 19 & 21 mm	10 sets	20 sets

Comfortable rubber grip



TORQUE MULTIPLIER WRENCH

KUNCI RODA TRUK REDUCER

ITEM NO.	SIZE	BOX	CTN
346-214	21, 38, 41 mm	1 set	3 sets

Bolt remover tool for truck wheels and other
Heavy equipment machine
High quality material



3 WAY T - SOCKET

KUNCI SOK T 3 IN 1

ITEM NO.	SIZE	BOX	CTN
346-106	8 x 9 x 10 mm	50 pcs	100 pcs
346-107	8 x 10 x 12 mm	50 pcs	100 pcs
346-108	10 x 11 x 13 mm	50 pcs	100 pcs
346-109	10 x 12 x 14 mm	50 pcs	100 pcs
346-110	12 x 14 x 17 mm	50 pcs	100 pcs

Hardened & tempered in chrome vanadium



T - TYPE SOCKET WRENCH

KUNCI SOK T CR-V HANDLE KARET HITAM

ITEM NO.	SIZE	BOX	CTN
346-113	11 mm	10 pcs	50 pcs
346-115	13 mm	10 pcs	50 pcs

Chrome vanadium material



T - TYPE SOCKET WRENCH SLIDING

KUNCI SOK T SLIDING

ITEM NO.	SIZE	BOX	CTN
346-124	12 mm	10 pcs	50 pcs
346-126	14 mm	10 pcs	50 pcs
346-127	17 mm	10 pcs	50 pcs

Special design

Chrome vanadium material



T - TYPE SOCKET WRENCH

KUNCI SOK T CR-V HITAM

ITEM NO.	SIZE	CTN
346-131	8 mm	50 pcs
346-132	10 mm	50 pcs
346-133	11 mm	50 pcs
346-134	12 mm	50 pcs
346-135	13 mm	50 pcs
346-136	14 mm	50 pcs
346-137	17 mm	50 pcs

Heavy duty

Cold stamped in black finished



T - TYPE SOCKET WRENCH ROTARY

KUNCI SOK T ROTARI

ITEM NO.	SIZE	BOX	CTN
346-146	8 mm	10 pcs	50 pcs
346-147	10 mm	10 pcs	50 pcs
346-149	14 mm	10 pcs	50 pcs
346-150	17 mm	10 pcs	50 pcs

Plastic rotary handle
Chrome vanadium material



T - TYPE SOCKET WRENCH

KUNCI SOK T GAGANG KARET

ITEM NO.	SIZE	BOX	CTN
346-282	11 mm	10 pcs	50 pcs
346-283	12 mm	10 pcs	50 pcs
346-284	13 mm	10 pcs	50 pcs
346-285	14 mm	10 pcs	50 pcs
346-287	19 mm	10 pcs	50 pcs

Comfortable dipped grip
Chrome vanadium material



Y - TYPE SOCKET WRENCH

KUNCI SOK Y KHRUM

ITEM NO.	SIZE	CTN
346-141	8 x 9 x 10 mm	100 pcs
346-142	8 x 10 x 12 mm	100 pcs
346-143	10 x 11 x 13 mm	100 pcs
346-144	10 x 12 x 14 mm	100 pcs
346-145	12 x 14 x 17 mm	100 pcs

Carbon steel standard
Cold stamped in chrome finished



Y - TYPE SOCKET WRENCH LONG

KUNCI SOK Y HITAM LONG

ITEM NO.	SIZE	CTN
346-151	8 x 9 x 10 mm	50 pcs
346-152	8 x 10 x 12 mm	50 pcs
346-153	10 x 11 x 13 mm	50 pcs
346-154	10 x 12 x 14 mm	50 pcs
346-155	12 x 14 x 17 mm	50 pcs

Heavy duty
Cold stamped in black finished



SCREWDRIVER

OBENG TEMBUS GAGANG TRANSPARAN

ITEM NO.	SIZE	BOX	CTN
348-001	⊖ 3" x 5 mm	1 dzn	20 dzn
348-002	⊕ 3" x 5 mm	1 dzn	20 dzn
348-003	⊖ 4" x 6 mm	1 dzn	20 dzn
348-004	⊕ 4" x 6 mm	1 dzn	20 dzn
348-005	⊖ 5" x 6 mm	1 dzn	20 dzn
348-006	⊕ 5" x 6 mm	1 dzn	20 dzn
348-007	⊖ 6" x 6 mm	1 dzn	20 dzn
348-008	⊕ 6" x 6 mm	1 dzn	20 dzn
348-009	⊖ 8" x 8 mm	1 dzn	10 dzn
348-010	⊕ 8" x 8 mm	1 dzn	10 dzn
348-011	⊖ 10" x 8 mm	1 dzn	10 dzn
348-012	⊕ 10" x 8 mm	1 dzn	10 dzn

High quality material

SCREWDRIVER CR-V BLUE HANDLE

OBENG TEMBUS CR-V GAGANG BIRU



ITEM NO.	SIZE	BOX	CTN
348-130	⊕ 3" x 5mm	1 dzn	10 dzn
348-131	⊖ 3" x 5mm	1 dzn	10 dzn
348-132	⊕ 4" x 6mm	1 dzn	10 dzn
348-133	⊖ 4" x 6mm	1 dzn	10 dzn
348-134	⊕ 5" x 6mm	1 dzn	10 dzn
348-135	⊖ 5" x 6mm	1 dzn	10 dzn
348-136	⊕ 6" x 6mm	1 dzn	10 dzn
348-137	⊖ 6" x 6mm	1 dzn	10 dzn
348-138	⊕ 8" x 6mm	1 dzn	10 dzn
348-139	⊖ 8" x 6mm	1 dzn	10 dzn

Chrome vanadium material

CR-V MACHINIST SCREWDRIVER

OBENG TEMBUS 7 PCS



ITEM NO.	SIZE	CTN
348-015	⊖ 8 x 8" ⊖ 6 x 6" ⊖ 6 x 4" ⊖ 5 x 3" ⊕ PH 3# 8 x 6" ⊕ PH 2# 6 x 4" ⊕ PH 1# 5 x 3"	25 sets

2 color blue and orange handle
CR-V, satin finished blade with power nut



SCREWDRIVER

OBENG CEBOL CR-V



ITEM NO.	SIZE	BOX	CTN
348-081	⊕ 1,5" x 6 mm	1 dzn	20 dzn
348-082	⊖ 1,5" x 6 mm	1 dzn	20 dzn

Heavy duty CR-V steel material
Bright yellow plastic handle

SCREWDRIVER SET

OBENG CEBOL 2 PCS



ITEM NO.	SIZE	BOX	CTN
348-083	38mm x 6 mm	10 sets	200 sets

Combination plastic and rubber grip handle
Chrome vanadium material

SCREWDRIVER

OBENG COLORLINE CR-V



ITEM NO.	SIZE	BOX	CTN
348-021	⊕ 3" x 6 mm	1 dzn	20 dzn
348-022	⊖ 3" x 6 mm	1 dzn	20 dzn
348-023	⊕ 4" x 6 mm	1 dzn	20 dzn
348-024	⊖ 4" x 6 mm	1 dzn	20 dzn
348-025	⊕ 5" x 6 mm	1 dzn	20 dzn
348-026	⊖ 5" x 6 mm	1 dzn	20 dzn
348-027	⊕ 6" x 6 mm	1 dzn	20 dzn
348-028	⊖ 6" x 6 mm	1 dzn	20 dzn
348-029	⊕ 8" x 6 mm	1 dzn	20 dzn
348-030	⊖ 8" x 6 mm	1 dzn	20 dzn

Chrome vanadium material
Crystal handle wrapped with rubber

SCREWDRIVER

OBENG GAGANG KARET CR-V



ITEM NO.	SIZE	BOX	CTN
348-141	⊕ 4" x 6 mm	1 dzn	20 dzn
348-142	⊖ 4" x 6 mm	1 dzn	20 dzn
348-143	⊕ 5" x 6 mm	1 dzn	20 dzn
348-144	⊖ 5" x 6 mm	1 dzn	20 dzn
348-145	⊕ 6" x 6 mm	1 dzn	20 dzn
348-146	⊖ 6" x 6 mm	1 dzn	20 dzn

Chrome vanadium material with rubber handle

ELECTRIC SCREWDRIVER

OBENG ELEKTRONIK CR-V



ITEM NO.	SIZE	BOX	CTN
348-541	⊕ 3" x 3 mm	2 dzn	100 dzn
348-542	⊖ 3" x 3 mm	2 dzn	100 dzn
348-543	⊕ 4" x 3 mm	2 dzn	100 dzn
348-544	⊖ 4" x 3 mm	2 dzn	100 dzn
348-045	⊕ 5" x 3 mm	2 dzn	100 dzn
348-046	⊖ 5" x 3 mm	2 dzn	100 dzn
348-047	⊕ 6" x 3 mm	2 dzn	100 dzn
348-048	⊖ 6" x 3 mm	2 dzn	100 dzn
348-049	⊕ 8" x 3 mm	2 dzn	60 dzn
348-050	⊖ 8" x 3 mm	2 dzn	60 dzn

Chrome vanadium material



CR-V STEEL SCREWDRIVER

OBENG T ROTARI

ITEM NO.	SIZE	BOX	CTN
348-109	PH 2	10 pcs	50 pcs

Plastic rotary handle
Chrome vanadium material with tip of the philips

2-END ADJUSTABLE RATCHET SCREWDRIVER "T" HANDLE

OBENG RATCHET MODEL T BOLAK BALIK



ITEM NO.	SIZE	BOX	CTN
348-191	H 6 x 160 mm	12 pcs	120 pcs

Professional
Chrome vanadium material with plastic handle

2-END ADJUSTABLE RATCHET SCREWDRIVER

OBENG RATCHET BOLAK BALIK



ITEM NO.	SIZE	BOX	CTN
348-192	H 6 x 175 mm	12 pcs	120 pcs

Professional
Chrome vanadium material with plastic handle



ELECTRICAL SCREWDRIVER SET

OBENG LISTRIK

ITEM NO.	SIZE	BOX	CTN
348-101	5 pcs	10 sets	50 sets

Philips :

⊕ 3" x 3 mm ⊕ 4" x 5 mm

Slotted:

⊖ 3" x 3 mm ⊖ 5" x 6 mm

⊖ 4" x 4 mm

Fit for any electric tools



ELECTRIC PEN

OBENG TESPEN

ITEM NO.	SIZE	BOX	CTN
348-111	7"	12 pcs	240 pcs

For testing 100 up to 500V



VOLTAGE TESTER

OBENG TESPEN TEGANGAN DC

ITEM NO.	SIZE	BOX	CTN
348-115	6 - 24 Volt	25 pcs	200 pcs

With cable test lead



FARADIC TESTER

OBENG FARADIC TESTER

ITEM NO.	SIZE	BOX	CTN
348-116	5,5"	24 pcs	240 pcs

Strong bright light signal

For testing 70 up to 250V



PRECISION SCREWDRIVER

OBENG ARLOJI



ITEM NO.	SIZE	BOX	CTN
348-121	6 pcs Philips : #00, #0, #1 Slotted : 1.4, 1.8, 2.4	12 sets	120 sets

Black finished in ABS body

PRECISION SCREWDRIVER

OBENG ARLOJI CR-V



ITEM NO.	SIZE	BOX	CTN
348-122	6 pcs Philips : #00, #0, #1 Slotted : 1.4, 2, 2.4	12 sets	72 sets

Carbon steel tip

GLASSES FRAME MAINTENANCE KIT

OBENG KACAMATA 12 IN 1



ITEM NO.	SIZE	BOX	CTN
391-022	13 pcs ⊖ Philips: PH1.5, PH1.7, PH2.0 ⊕ Slotted: SL1.5, SL1.7, SL2.0 ⊙ HN2.0, HN2.3, HN2.4, HN2.5, HN 2,6 ⊗ Tn8	10 sets	80 sets

Small and handy packaging wallet



MOBILE PHONE SCREWDRIVER

OBENG HANDPHONE

ITEM NO.	SIZE	BOX	CTN
348-106	4 pcs T5, T6, T8, & M2,6	12 sets	72 sets

Fit for any mobile phone



15 IN 1 PRECISION SCREWDRIVER

OBENG 15 IN 1

ITEM NO.	SIZE	BOX	CTN
348-213	⊕ PH0, PH1, PH2 ⊖ H1.5, H2.0 H2.5 ⊗ T5, T6, T7, T8 ⊕ 2.0, 3.0 ⊗ 2.0 ⊖ 2.0, 2.5	10 sets	120 sets

S2 material



10 IN 1 PRECISION SCREWDRIVER

OBENG CR-V 10 IN 1

ITEM NO.	SIZE	BOX	CTN
348-215	A: T6, T8, T10, T15 PH0, PH1, PH2 ⊖ 2.0, 3.0, 5.0 B: Y0, Y1, Y2 ⊕ 2.0, 2.3 ⊗ 1, 2 H2.0, H2.5, H3.0 C: T6, T8, U4, U6 ⊖ 2.0, 3.0 PH0, PH00, PH1, S1	10 sets	100 sets

Chrome vanadium material

**IMPACT DRIVER BITS**

MATA OBENG KETOK 6 PCS



ITEM NO.	SIZE	BOX	CTN
348-151	PH 2 x 80 mm	20 sets	60 sets
348-152	PH 3 x 80 mm	10 sets	50 sets

6 pcs bit set
Chrome vanadium material

IMPACT DRIVER BITS

MATA OBENG KETOK BROWN 10 PCS



ITEM NO.	SIZE	BOX	CTN
348-156	PH 2 x 80 mm	20 sets	60 sets
348-157	PH 3 x 80 mm	20 sets	60 sets

10 pcs magnetic bit set
S2 material

IMPACT SCREWDRIVER

OBENG KETOK 5 PCS



ITEM NO.	SIZE	BOX	CTN
348-161	⊕ Philips : PH 2, PH 3 ⊖ Slotted : 8 & 10 mm	1 set	20 sets

Drop forged steel construction
4 impact driver bits included

IMPACT SCREWDRIVER

OBENG KETOK 12 PCS



ITEM NO.	SIZE	BOX	CTN
348-163	⊖ 8 x 36, 10 x 36, 8 x 80, 9 x 71, 10 x 80 mm ⊕ PH 2 x 36, 3 x 36, PH 2 x 80, 3 x 80, PH 1 x 67 mm	1 set	20 sets

Drop forged steel construction
10 impact driver bits included

POWER BITS

MATA OBENG ANGIN 10 PCS

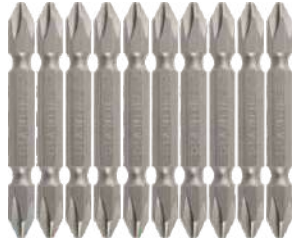

ITEM NO.	SIZE	BOX	CTN
348-181	65 mm x PH 2	10 sets	100 sets

Chrome vanadium material

POWER BITS

MATA OBENG ANGIN 10 PCS



ITEM NO.	SIZE	BOX	CTN
348-182	65 mm x Slot 6	10 sets	100 sets

Chrome vanadium material



5 PCS HOLLOW PUNCH PLONG KULIT SET 5 PCS



ITEM NO.	SIZE	BOX	CTN
362-201	3/16", 1/4", 5/16", 3/8", 1/2"	12 sets	48 sets

Chrome vanadium material
Knurled body for better grip

12 PCS HOLLOW PUNCH PLONG KULIT SET 12 PCS



ITEM NO.	SIZE	BOX	CTN
362-202	1/8", 5/32", 3/16", 7/32", 1/4", 5/16", 3/8", 7/16", 1/2", 9/16", 5/8", 3/4"	5 sets	20 sets

Chrome vanadium material
Knurled body for better grip



VERNIER CALIPER

SKETMAT BESI

ITEM NO.	SIZE	BOX	CTN
367-001	6"	10 pcs	50 pcs
367-002	8"	10 pcs	50 pcs
367-006	12"	10 pcs	20 pcs

High precision measurement
Pouch included
Accuracy 0.05 mm



DIGITAL CALIPER

SKETMAT DIGITAL

ITEM NO.	SIZE	BOX	CTN
367-003	6"	10 pcs	50 pcs

CE standard, metr. ISO - GEW
High precision caliper
Accuracy 0.01 mm



DIAL CALIPER

SKETMAT DIAL

ITEM NO.	SIZE	BOX	CTN
367-007	6"	10 pcs	50 pcs

Stainless hardened material
Accuracy 0.02 mm



MICROMETER

MIKROMETER

ITEM NO.	SIZE	CTN
367-051	0 - 25 mm	50 pcs
367-052	25 - 50 mm	50 pcs
367-053	50 - 75 mm	36 pcs
367-054	75 - 100 mm	25 pcs

High accuracy measurement
Japan standard, accuracy 0.01 mm



HAND STAPLER

STAPLES



ITEM NO.	SIZE	BOX	CTN
358-001	4 - 8 mm	10 pcs	40 pcs

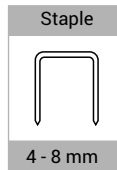

6 mm staples included

HAND STAPLER 3 IN 1

STAPLES 3 IN 1



ITEM NO.	SIZE	BOX	CTN
358-002	4 - 14 mm	10 pcs	40 pcs

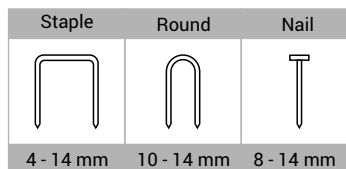

8 mm staples included
High grade steel construction

STAPLES GUN

STAPLES 4 IN 1



ITEM NO.	SIZE	BOX	CTN
358-021	6 - 15 mm	6 pcs	24 pcs

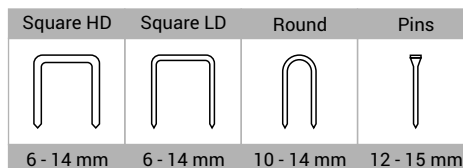

Heavy duty steel construction
400 staples/box
High/low power switch



COMBINATION PLIERS

TANG KOMBINASI SATIN

ITEM NO.	SIZE	BOX	CTN
347-001	6"	6 pcs	60 pcs
347-002	7"	6 pcs	60 pcs
347-003	8"	6 pcs	60 pcs

Comfortable rubber grip
Chrome vanadium satin finished

LONG NOSE PLIERS

TANG LANCIP SATIN



ITEM NO.	SIZE	BOX	CTN
347-011	6"	6 pcs	60 pcs

Comfortable rubber grip
Chrome vanadium satin finished

DIAGONAL CUTTING PLIERS

TANG POTONG SATIN



ITEM NO.	SIZE	BOX	CTN
347-021	6"	6 pcs	60 pcs

Comfortable rubber grip
Chrome vanadium satin finished

STRIP WIRE PLIERS

TANG KUPAS KABEL SATIN



ITEM NO.	SIZE	BOX	CTN
347-066	6"	6 pcs	60 pcs

Comfortable rubber grip
Chrome vanadium satin finished



COMPOUND COMBINATION PLIERS

TANG KOMBINASI HEAVY DUTY



ITEM NO.	SIZE	BOX	CTN
347-004	8"	6 pcs	60 pcs

Soft material for comfortable grip
Lock switch

ELECTRIC CUTTING PLIERS

TANG POTONG ELEKTRIK



ITEM NO.	SIZE	BOX	CTN
347-023	125 mm	6 pcs	120 pcs
347-024	160 mm	6 pcs	120 pcs

Used for cutting plastic, electric wire component, plastic molding etc.
High carbon steel material
Super sharp

4 PCS PLIERS SET

TANG 4 PCS



ITEM NO.	SIZE	BOX	CTN
347-099	6"	6 sets	24 sets
Combination pliers Diagonal Pliers Long Nose Pliers Ext. Bent Circlip Pliers			

Ergonomic design for comfortable, firm grip
C55 high carbon steel, hardened cutting edges



COMBINATION PLIERS

TANG KOMBINASI KHROM

ITEM NO.	SIZE	BOX	CTN
347-007	6"	6 pcs	60 pcs
347-008	7"	6 pcs	60 pcs
347-009	8"	6 pcs	60 pcs

Chrome finished

LONG NOSE PLIERS

TANG LANCIP KHROM



ITEM NO.	SIZE	BOX	CTN
347-012	6"	6 pcs	60 pcs

Chrome finished

DIAGONAL CUTTING PLIERS

TANG POTONG KHROM



ITEM NO.	SIZE	BOX	CTN
347-022	6"	6 pcs	60 pcs

Chrome finished

SLIP-JOINT PLIERS

TANG SLIP JOINT



ITEM NO.	SIZE	BOX	CTN
347-046	6"	6 pcs	120 pcs
347-047	8"	6 pcs	72 pcs

Chrome finished



COMBINATION MINI PLIERS

TANG KOMBINASI MINI



ITEM NO.	SIZE	BOX	CTN
347-000	4.5"	24 pcs	240 pcs

ISO 9002 certificate

DIAGONAL CUTTING MINI PLIERS

TANG POTONG MINI



ITEM NO.	SIZE	BOX	CTN
347-006	4.5"	12 pcs	240 pcs

ISO 9002 certificate

LONG NOSE MINI PLIERS

TANG LANCIP MINI



ITEM NO.	SIZE	BOX	CTN
347-016	4.5"	24 pcs	240 pcs

ISO 9002 certificate

NAIL CUTTING MINI PLIERS

TANG KAKAKTUA MINI



ITEM NO.	SIZE	BOX	CTN
347-026	4.5"	24 pcs	240 pcs

ISO 9002 certificate

BENT NOSE MINI PLIERS

TANG LANCIP BENGKOK MINI



ITEM NO.	SIZE	BOX	CTN
347-071	4.5"	24 pcs	240 pcs

ISO 9002 certificate

5 PCS MINI PLIERS SET

TANG MINI SATIN SET 5 PCS

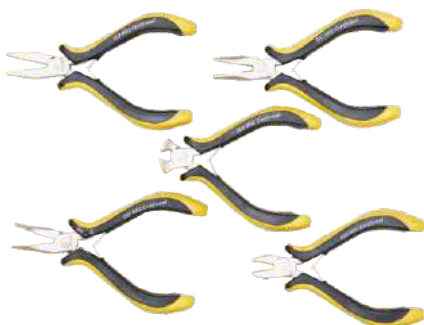

ITEM NO.	DESC	BOX	CTN
347-100	Long nose Bent nose Straight nose Diagonal cutting Nail cutting	5 sets	50 sets

4" - 5", 5 pcs multi shape mini pliers



CURVED JAW LOCKING PLIER

TANG BUAYA MODEL OVAL



ITEM NO.	SIZE	BOX	CTN
347-031	10"	6 pcs	48 pcs

Carbon Steel
Stamped & hardened steel jaws
Nickel plated

STRAIGHT JAW LOCKING PLIER

TANG BUAYA MODEL FLAT



ITEM NO.	SIZE	BOX	CTN
347-032	10"	6 pcs	48 pcs

Carbon Steel
Stamped & hardened steel jaws
Nickel plated

ROUND JAW LOCKING PLIER

TANG BUAYA MODEL BULAT



ITEM NO.	SIZE	BOX	CTN
347-033	10"	6 pcs	48 pcs

Carbon Steel
Stamped & hardened steel jaws
Nickel plated

ROUND JAW LOCKING PLIER

TANG BUAYA MODEL BULAT HITAM



ITEM NO.	SIZE	BOX	CTN
347-040	10"	6 pcs	48 pcs

Carbon Steel
Stamped & hardened steel jaws
Black powder coating

EXTERNAL BENT CIRCLIP PLIERS

TANG SNAP RING BENGKOK BUKA

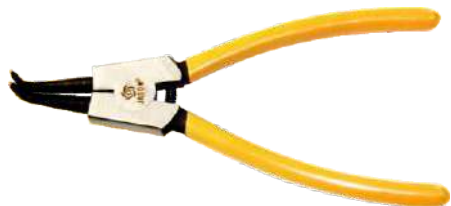

ITEM NO.	SIZE	BOX	CTN
347-051	7"	6 pcs	60 pcs

Carbon steel tip

EXTERNAL STRAIGHT CIRCLIP PLIERS

TANG SNAP RING LURUS BUKA



ITEM NO.	SIZE	BOX	CTN
347-052	7"	6 pcs	60 pcs

Carbon steel tip

INTERNAL BENT CIRCLIP PLIERS

TANG SNAP RING BENGKOK TUTUP



ITEM NO.	SIZE	BOX	CTN
347-053	7"	6 pcs	60 pcs

Carbon steel tip

INTERNAL STRAIGHT CIRCLIP PLIERS

TANG SNAP RING LURUS TUTUP

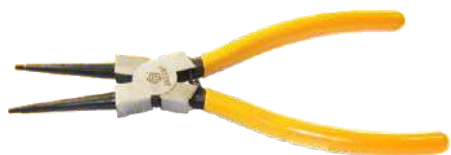

ITEM NO.	SIZE	BOX	CTN
347-054	7"	6 pcs	60 pcs

Carbon steel tip



HAND RIVETER

TANG RIVET BODI HITAM

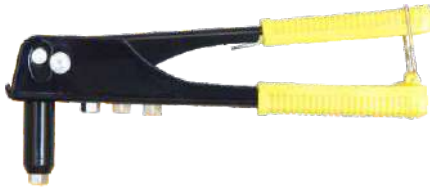

ITEM NO.	SIZE	BOX	CTN
347-041	9,5"	12 pcs	24 pcs

Comfortable plastic grip
Nozzle size: 3mm, 4mm, 5mm

HAND RIVETER

TANG RIVET HEAVY DUTY BODI KHROM



ITEM NO.	SIZE	BOX	CTN
347-042	10"	12 pcs	24 pcs

Comfortable plastic grip
Nozzle size: 3 mm, 4 mm, 5 mm

HAND RIVETER

TANG RIVET TIPE JAPAN



ITEM NO.	SIZE	BOX	CTN
347-043	10,5"	12 pcs	24 pcs

Nozzle size: 2.4 mm, 3.2 mm, 4.0 mm, 4.8 mm

HAND RIVETER

TANG RIVET FLEKSIBEL TIPE EROPA



ITEM NO.	SIZE	BOX	CTN
347-044	11,5"	12 pcs	24 pcs

Multi angle directional
Nozzle size: 2.4 mm, 3.2 mm, 4.0 mm, 4.8 mm



CARPENTER PINCER

TANG KAKAKTUA

ITEM NO.	SIZE	BOX	CTN
347-077	7"	6 pcs	72 pcs
347-078	8"	6 pcs	60 pcs

High quality material



TOWER PINCER

TANG KAKAKTUA BODI PANJANG

ITEM NO.	SIZE	BOX	CTN
347-094	9"	6 pcs	72 pcs
347-095	10"	6 pcs	72 pcs

High quality material



PIPE CUTTER

TANG POTONG PIPA PVC

ITEM NO.	SIZE	BOX	CTN
347-300	42 mm	12 pcs	48 pcs

Stainless blade
Extra ratchet special design
Everlasting sharp blade



SAW SET MASTER

TANG SIWARAN GERGAJI

ITEM NO.	SIZE	BOX	CTN
347-401	175 mm	10 pcs	60 pcs

Heavy duty zinc alloy



TERMINAL CRIMPING PLIER

TANG TERMINAL KOMPUTER



ITEM NO.	SIZE	BOX	CTN
347-065	6P & 8P	10 pcs	40 pcs

For cutting, stripping and crimping
2 type of plugs (RJ 45, RJ 12 & 9,5 mm, RJ 11)

AUTOMATIC WIRE STRIPPER

TANG KUPAS KABEL OTOMATIS



ITEM NO.	SIZE	BOX	CTN
347-067	7"	10 pcs	50 pcs

With depth measurement and cutting cable

AUTOMATIC WIRE STRIPPER

TANG KUPAS KABEL OTO BODI BESI

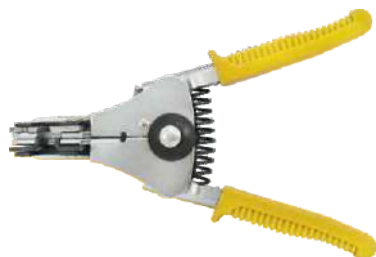

ITEM NO.	SIZE	BOX	CTN
347-068	1.0, 1.5, 2.0, 2.5mm	10 pcs	60 pcs

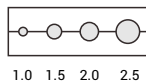

Easy to use



NEW ELECTRIC PLIERS

TANG SKUN KABEL SERBAGUNA

ITEM NO.	SIZE	BOX	CTN
347-069	8"	25 pcs	50 pcs

Jaws cap: 0.5, 0.75, 1, 1.5, 2.5, 4, 6, 10, 16



TERMINALS CRIMPING PLIER

TANG TERMINAL SKUN KABEL

ITEM NO.	SIZE	BOX	CTN
347-112	7,5"	12 pcs	96 pcs

For all kind of scone



CABLE CUTTER

GUNTING KABEL

ITEM NO.	SIZE	BOX	CTN
362-090	10"	6 pcs	48 pcs

Fully hardened & tempered steel blade



ADJUSTABLE SPANNER FOR ELECTRIC GRINDER

KUNCI DISGRINDER



ITEM NO.	SIZE	BOX	CTN
353-200	7"	6 pcs	60 pcs

Fit for any electric grinder
Flexible size

PUNCH PLIER

TANG PLONG KULIT ROTARI



ITEM NO.	SIZE	BOX	CTN
347-201	8"	6 pcs	60 pcs

Chrome plated
6 adjustable hole size (2, 2.5, 3, 3.5, 4, 4.5 mm)

STRAPING MACHINE

ALAT STRAPING BAN PLASTIK



ITEM NO.	SIZE	BOX	CTN
362-007	12 - 16 mm	1 set	6 sets

High quality

SPRING BALANCER



ITEM NO.	SIZE	BOX	CTN
373-304	3 - 5 kg	1 pc	50 pcs

Best quality



HEAVY DUTY "F" CLAMP

CATOK F HEAVY DUTY

ITEM NO.	SIZE	CTN
356-021	100 x 300 mm	20 pcs
356-022	120 x 400 mm	10 pcs
356-023	120 x 500 mm	10 pcs
356-024	120 x 600 mm	10 pcs
356-025	120 x 800 mm	6 pcs
356-026	120 x 1000 mm	6 pcs
356-027	120 x 1200 mm	6 pcs

Fine drop forged steel
International standard quality



HEAVY DUTY C CLAMP

CATOK C HEAVY DUTY

ITEM NO.	SIZE	BOX	CTN
356-101	4"	6 pcs	36 pcs
356-102	5"	6 pcs	24 pcs
356-103	6"	6 pcs	24 pcs
356-104	8"	5 pcs	10 pcs
356-105	10"	5 pcs	10 pcs
356-106	12"	5 pcs	10 pcs

Heavy duty
High quality material

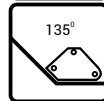
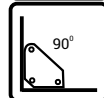
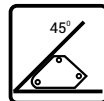

4 PCS MAGNETIC WELDING HOLDER

SIKU MAGNET MINI 4 PCS

ITEM NO.	SIZE	BOX	CTN
356-111	2" (9 Lbs)	12 sets	24 sets

Specification: 2-3/8" x 2"

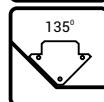
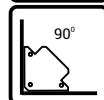
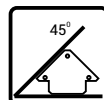

MAGNETIC WELDING HOLDER

SIKU MAGNET WELDING

ITEM NO.	SIZE	BOX	CTN
356-112	3" (25 Lbs)	10 pcs	40 pcs
356-113	4" (50 Lbs)	12 pcs	36 pcs
356-114	5" (75 Lbs)	6 pcs	24 pcs

Corner: 45°, 90°, 135°



HEAVY DUTY BENCH VISE W/ ANVIL

CATOK PARON



ITEM NO.	SIZE	CTN
356-011	3"/5,5 kg	1 pc
356-012	4"/9,5 kg	1 pc
356-013	5"/15 kg	1 pc
356-014	6"/23 kg	1 pc
356-015	8"/37 kg	1 pc

Solid cast iron
Finished in black hammertone

CLAMP VISE

CATOK MEJA



ITEM NO.	SIZE	BOX	CTN
356-071	60 mm	1 pc	20 pcs

High quality material

HINGE PIPE VISE

CATOK PIPA



ITEM NO.	SIZE	CTN
356-083	No: 2 (10 - 90 mm)	4 pcs
356-084	No: 3 (15 - 115 mm)	4 pcs
356-085	No: 4 (15 - 165 mm)	2 pcs

Heavy duty

PLASTIC SPRING CLAMP

SPRING KLEM



ITEM NO.	SIZE	BOX	CTN
356-122	4"	40 pcs	240 pcs
356-124	6"	20 pcs	120 pcs

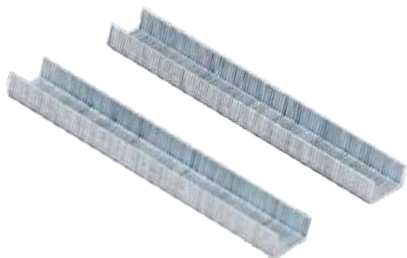

SQUARE STAPLES

ISI STAPLES MODEL SQUARE

ITEM NO.	SIZE	BOX	CTN
358-011	6 mm	50 ktk	200 ktk
358-012	8 mm	50 ktk	200 ktk
358-033	10 mm	20 ktk	100 ktk
358-034	12 mm	20 ktk	100 ktk
358-035	14 mm	20 ktk	100 ktk

High quality material
1000 staples per box



T - SHAPE STAPLES

ISI STAPLES MODEL T

ITEM NO.	SIZE	BOX	CTN
358-043	10 mm	50 ktk	200 ktk
358-044	12 mm	50 ktk	200 ktk
358-045	14 mm	50 ktk	200 ktk

High quality material
1000 staples per box



NAILS STAPLES

ISI STAPLES ANGIN

ITEM NO.	TYPE	BOX	CTN
358-013	F-10	5000 pcs	30 ktk
358-014	F-15	5000 pcs	30 ktk
358-015	F-20	5000 pcs	20 ktk
358-016	F-25	5000 pcs	20 ktk
358-017	F-30	5000 pcs	20 ktk

Nail
High quality material



SQUARE STAPLES

ISI STAPLES ANGIN

ITEM NO.	TYPE	BOX	CTN
358-060	1006 J	5000 pcs	30 ktk
358-061	1008 J	5000 pcs	30 ktk
358-062	1010 J	5000 pcs	30 ktk
358-063	1013 J	5000 pcs	25 ktk
358-070	406 J	5000 pcs	50 ktk
358-071	408 J	5000 pcs	50 ktk
358-072	410 J	5000 pcs	30 ktk
358-073	413 J	5000 pcs	30 ktk

Square nail
High quality material

PRESSURE GAUGE MANOMETER



ITEM NO.	SIZE	CTN
374-003	2 1/2" x 10 kg	100 pcs
374-004	2 1/2" x 16 kg	100 pcs
374-005	2 1/2" x 20 kg	100 pcs
374-006	2 1/2" x 25 kg	100 pcs
374-008	2 1/2" x 200 kg	100 pcs

High precision measurement

ALL BRASS MINI GAS VALVE KRAN KOMPRESOR KUNINGAN



ITEM NO.	SIZE	BOX	CTN
373-401	1/4"	20 pcs	240 pcs

All brass material

RECOIL HOSE PU



ITEM NO.	SIZE	CTN
395-001	6 m	100 rol
395-002	9 m	50 rol
395-003	12 m	40 rol

Polyurethane tube 8 x 5 mm
Made in Taiwan

WIRE BOWL BRUSH

SIKAT MANGKOK



ITEM NO.	SIZE	BOX	CTN
361-011	3" x M10 x 1,5 SS	10 pcs	100 pcs
361-012	4" x M14 x 2,0 SS	5 pcs	50 pcs
361-013	3" x M10 x 1,5 Steel	10 pcs	100 pcs
361-014	4" x M14 x 2,0 Steel	5 pcs	50 pcs

Fit for any angle grinder

TWISTED WIRE BOWL BRUSH

SIKAT MANGKOK KEPANG



ITEM NO.	SIZE	BOX	CTN
361-015	3" x M10 x 1,5	10 pcs	100 pcs

Strong twisted wire

END WIRE BRUSH W/ SHANK

SIKAT BAJA GREENDA TANGKAI



ITEM NO.	SIZE	BOX	CTN
361-031	12 x 27 mm	50 pcs	500 pcs
361-032	19 x 27 mm	40 pcs	400 pcs
361-033	24 x 27 mm	40 pcs	400 pcs
361-034	28 x 28 mm	20 pcs	200 pcs

Strong crimped wire
Fit for any drill



BOWL TYPE BRUSH W/ SHANK

SIKAT BAJA GREENDA MANGKOK

ITEM NO.	SIZE	BOX	CTN
361-035	50 mm	12 pcs	120 pcs
361-036	63 mm	10 pcs	100 pcs
361-037	75 mm	10 pcs	100 pcs

Strong crimped wire
Fit for any drill



CIRCULAR TYPE WIRE BRUSH W/ SHANK

SIKAT BAJA GREENDA BULAT

ITEM NO.	SIZE	BOX	CTN
361-038	38 mm	20 pcs	200 pcs
361-039	50 mm	15 pcs	150 pcs
361-040	63 mm	15 pcs	150 pcs
361-041	75 mm	12 pcs	120 pcs

Strong crimped wire
Fit for any drill



3 PCS WIRE BRUSH SET

SIKAT BAJA GREENDA 3 PCS

ITEM NO.	SIZE	BOX	CTN
361-042	50mmx1/4" (Wheel) 8 sets		80 sets
	50mmx1/4" (Cup)		
	25mmx1/4" (End)		

Strong crimped wire
Fit for any drill



5 PCS WIRE BRUSH SET

SIKAT BAJA GREENDA 5 PCS

ITEM NO.	SIZE	BOX	CTN
361-043	50mmx1/4" (Wheel) 4 sets		20 sets
	75mmx1/4" (Wheel)		
	50mmx1/4" (Cup)		
	75mmx1/4" (Cup)		
	25mmx1/4" (End)		

Strong crimped wire
Fit for any drill



METAL CUT OFF WHEELS

BATU POTONG

ITEM NO.	SIZE	BOX	CTN
369-005	4" x 1,2 mm	50 pcs	800 pcs

For steel & Stainless steel
Max RPM 15.200/mins

METAL CUTTING DISC

BATU POTONG



ITEM NO.	SIZE	BOX	CTN
369-006	4" x 2 mm	50 pcs	500 pcs
369-008	14" x 3,2 mm	25 pcs	25 pcs

For steel
Max RPM 15.200/mins (369-006)
Max RPM 3.900/mins (369-008)

METAL GRINDING DISC

BATU GURINDA



ITEM NO.	SIZE	BOX	CTN
369-016	100 x 6 x 16 mm	25 pcs	200 pcs

High quality
Max RPM 15.300/mins

GRINDING WHEEL

BATU GURINDA ABU-ABU



ITEM NO.	SIZE	CTN
369-027	6" x 1 x 1 & 1 1/4 - A60	20 pcs
369-034	10" x 1 x 1 & 1 1/4 - A46	10 pcs
369-037	12" x 1 1/2 x 1 1/4 - A46	10 pcs

Max RPM : 4.450/mins
Shape code : No. 1

GRINDING WHEEL

BATU GURINDA HIJAU



ITEM NO.	SIZE	CTN
369-039	6" x 1 x 1 & 1 1/4 - GC80	20 pcs
369-040	6" x 1 x 1 & 1 1/4 - GC100	20 pcs

Max RPM : 4.450/mins
Shape code : No. 1



BALL VALVE

BALL VALVE PVC POLOS

ITEM NO.	SIZE	BOX	CTN
378-201	1/2"	12 pcs	360 pcs
378-202	3/4"	12 pcs	360 pcs
378-203	1"	12 pcs	240 pcs

EPDM seats and seals
150 PSI

BALL VALVE THREAD

BALL VALVE PVC DRAT



ITEM NO.	SIZE	BOX	CTN
378-204	1/2"	12 pcs	360 pcs
378-205	3/4"	12 pcs	360 pcs
378-206	1"	12 pcs	240 pcs

Fine heavy duty PVC

GATE VALVE

STOP KRAN KUNINGAN



ITEM NO.	SIZE	BOX	CTN
378-222	3/4" (330gr)	6 pcs	60 pcs
378-223	1" (480gr)	5 pcs	40 pcs

Full brass material

COMBINATION NIPPLE

NEPEL KING BSPT SEGI ENAM



ITEM NO.	SIZE	CTN
378-041	1/2"	350 pcs
378-042	3/4"	200 pcs
378-043	1"	200 pcs
378-044	1 1/4"	100 pcs
378-045	1 1/2"	50 pcs
378-046	2"	50 pcs

Chrome steel material
Can be used to connect the pump with the hose

COMBINATION NIPPLE

NEPEL KING BSPT



ITEM NO.	SIZE	CTN
378-047	2 1/2"	36 pcs
378-048	3"	25 pcs
378-049	4"	16 pcs
378-050	6"	5 pcs
378-051	8"	2 pcs

Chrome steel material
Can be used to connect the pump with the hose

SHORT STEEL PADLOCK

GEMBOK PENDEK HITAM



ITEM NO.	SIZE	BOX	CTN
381-021	40 mm	1 dzn	8 dzn
381-022	50 mm	1 dzn	6 dzn
381-023	60 mm	1 dzn	6 dzn

With brass cylinder
Against drill, saw and versatile key

LONG STEEL PADLOCK

GEMBOK PANJANG HITAM



ITEM NO.	SIZE	BOX	CTN
381-031	40 mm	1 dzn	8 dzn
381-032	50 mm	1 dzn	6 dzn
381-033	60 mm	1 dzn	6 dzn

With brass cylinder
Against drill, saw and versatile key



DIAMOND STEEL PADLOCK
GEMBOK SEGITIGA PANJANG

ITEM NO.	SIZE	BOX	CTN
381-051	40 mm	6 pcs	8 dzn
381-052	50 mm	6 pcs	8 dzn
381-053	60 mm	6 pcs	6 dzn

With brass cylinder
Against drill, saw and versatile body



DIAMOND STEEL PADLOCK
GEMBOK SEGITIGA PENDEK

ITEM NO.	SIZE	BOX	CTN
381-056	40 mm	6 pcs	8 dzn
381-057	50 mm	6 pcs	8 dzn
381-058	60 mm	6 pcs	6 dzn

With brass cylinder
Against drill, saw and versatile body



MASTER KEY DIAMOND STEEL PADLOCK
GEMBOK SEGITIGA PANJANG 3 PCS

ITEM NO.	SIZE	BOX	CTN
381-061	40 mm	6 sets	24 sets
381-062	50 mm	6 sets	24 sets
381-063	60 mm	6 sets	24 sets

With brass cylinder
Against drill, saw and versatile key
Master key for opening 3 padlocks



MASTER KEY DIAMOND STEEL PADLOCK
GEMBOK SEGITIGA PENDEK 3 PCS

ITEM NO.	SIZE	BOX	CTN
381-066	40 mm	6 sets	24 sets
381-067	50 mm	6 sets	24 sets
381-068	60 mm	6 sets	24 sets

With brass cylinder
Against drill, saw and versatile key
Master key for opening 3 padlocks



POLYPROPYLENE ROPE

TALI PROPYLENE



ITEM NO.	SIZE	BALL
385-211	6 mm x 220 m (38,5 kg)	10 rol
385-212	8 mm x 220 m (34,1 kg)	5 rol
385-213	10 mm x 220 m (42,24 kg)	4 rol
385-214	12 mm x 220 m (45,87 kg)	3 rol
385-215	14 mm x 220 m (41,36 kg)	2 rol
385-216	16 mm x 220 m (26,62 kg)	1 rol
385-217	18 mm x 220 m (33,88 kg)	1 rol
385-218	20 mm x 220 m (41,8 kg)	1 rol
385-219	22 mm x 220 m (50,6 kg)	1 rol
385-220	24 mm x 220 m (60,17 kg)	1 rol
385-221	28 mm x 220 m (80,96 kg)	1 rol
385-222	30 mm x 220 m (93,72 kg)	1 rol
385-223	32 mm x 220 m (106,37 kg)	1 rol
385-224	36 mm x 220 m (134,2 kg)	1 rol

General purpose rope, twisted
Made in Korea

POLYPROPYLENE MULTIFILAMENT ROPE

TALI PP MULTIFILAMENT



ITEM NO.	SIZE	BALL
385-231	6 mm x 220 m (38,5 kg)	10 rol
385-232	8 mm x 220 m (34,1 kg)	5 rol
385-233	10 mm x 220 m (42,24 kg)	4 rol
385-234	12 mm x 220 m (45,87 kg)	3 rol
385-235	14 mm x 220 m (41,36 kg)	2 rol
385-236	16 mm x 220 m (26,62 kg)	1 rol
385-237	18 mm x 220 m (33,88 kg)	1 rol
385-238	20 mm x 220 m (41,8 kg)	1 rol
385-239	22 mm x 220 m (50,6 kg)	1 rol
385-240	24 mm x 220 m (60,17 kg)	1 rol
385-241	28 mm x 220 m (80,96 kg)	1 rol
385-242	30 mm x 220 m (93,72 kg)	1 rol
385-243	32 mm x 220 m (106,37 kg)	1 rol
385-244	36 mm x 220 m (134,2 kg)	1 rol
385-245	40 mm x 220 m (167.2 kg)	1 rol

General purpose rope, twisted
Made in Korea

WEBBING SLING



ITEM NO.	SIZE	CTN
385-070	1 t x 1 m ungu	50 pcs
385-071	1 t x 2 m ungu	50 pcs
385-072	1 t x 3 m ungu	50 pcs
385-073	1 t x 4 m ungu	35 pcs
385-074	1 t x 5 m ungu	28 pcs
385-075	1 t x 6 m ungu	24 pcs
385-076	1 t x 8 m ungu	18 pcs
385-077	1 t x 10 m ungu	14 pcs
385-078	2 t x 1 m hijau	30 pcs
385-079	2 t x 2 m hijau	30 pcs
385-085	2 t x 3 m hijau	24 pcs
385-086	2 t x 4 m hijau	16 pcs
385-087	2 t x 5 m hijau	15 pcs
385-088	2 t x 6 m hijau	12 pcs
385-089	2 t x 8 m hijau	10 pcs
385-141	3 t x 3 m kuning	15 pcs
385-090	3 t x 4 m kuning	12 pcs
385-091	3 t x 5 m kuning	10 pcs
385-092	3 t x 6 m kuning	9 pcs
385-093	3 t x 8 m kuning	6 pcs
385-142	3 t x 10 m kuning	5 pcs
385-121	4 t x 3 m abu-abu	10 pcs
385-094	4 t x 4 m abu-abu	10 pcs
385-095	4 t x 5 m abu-abu	9 pcs
385-096	4 t x 6 m abu-abu	6 pcs
385-122	4 t x 8 m abu-abu	4 pcs
385-131	5 t x 3 m merah	10 pcs
385-097	5 t x 4 m merah	6 pcs
385-132	5 t x 5 m merah	6 pcs
385-098	5 t x 6 m merah	4 pcs
385-151	6 t x 3 m coklat	5 pcs
385-099	6 t x 4 m coklat	5 pcs
385-152	6 t x 5 m coklat	4 pcs
385-100	6 t x 6 m coklat	3 pcs
385-153	6 t x 8 m coklat	4 pcs
385-156	8 t x 6 m biru	3 pcs
385-161	10 t x 6 m orange	1 pc
385-162	10 t x 8 m orange	1 pc
385-163	10 t x 10 m orange	1 pc

Factory test certificate
Safety factor 1 : 7

OPEN TYPE CARGO BLOCK WITH SINGLE SHEAVE

KATROL BESI OPEN



ITEM NO.	SIZE	CTN
387-095	3" x 0.5 ton	20 pcs
387-096	4" x 1.0 ton	10 pcs
387-097	5" x 2.0 ton	6 pcs
387-098	6" x 3.2 ton	4 pcs
387-099	8" x 5.0 ton	3 pcs

High quality material

EYE HOOK

CARGO HOOK ALLOY STEEL



ITEM NO.	SIZE	CTN
387-201	0.5 ton	100 pcs
387-202	0.75 ton	100 pcs
387-203	1.0 ton	50 pcs
387-204	2.0 ton	40 pcs
387-205	3.0 ton	25 pcs
387-206	5.0 ton	15 pcs
387-207	10.0 ton	2 pcs

Heavy duty

Alloy steel material



CHAIN BLOCK KATROL HEAVY DUTY

ITEM NO.	SIZE	CTN
387-102	1 t x 3 m	1 set
387-104	2 t x 3 m	1 set
387-105	3 t x 3 m	1 set
387-106	5 t x 3 m	1 set
387-112	1 t x 5 m	1 set
387-114	2 t x 5 m	1 set
387-115	3 t x 5 m	1 set
387-116	5 t x 5 m	1 set
387-117	10 t x 5 m	1 set
387-210	2 t x 10 m	1 set
387-211	3 t x 10 m	1 set
387-212	5 t x 10 m	1 set
387-213	10 t x 10 m	1 set

Factory test certificate
Heavy duty
Color coded chain

ELECTRIC HOIST



ITEM NO.	SIZE	BOX	CTN
387-221	0.5 t x 930 w	1 set	2 sets
387-222	1.0 t x 1.700 w	1 set	1 set

Item No.	387-221		387-222	
	Load Capacity	250kg	500kg	500kg
Lifting Height	12m	6m	12m	6m
Lifting Speed	10m/min	5m/min	10m/min	5m/min
Cable Length	12m-		12m-	
Cable Diameter	4.0mm		5.6mm	
Resister Cable	≥ 1.250kg		≥ 2.500kg	
Service	S3 20%-10min		S3 20%-10min	
Main Voltage	220-230V-50Hz		220-230V-50Hz	
Motor Performance	P930W		P1.700W	

LEVER BLOCK



ITEM NO.	SIZE	CTN
387-303	1.5 t x 1.5 m	1 set
387-304	3.0 t x 1.5 m	1 set

Factory test certificate
Heavy duty

ELECTRIC CHAIN HOIST



ITEM NO.	SIZE	CTN
387-231	1 t x 6 m - Lifting height : 6 m - Lifting speed : 4,30 m/min - Power : 1,1 kw - Voltage : 380V/50HZ/3PH	1 set
387-232	2 t x 6 m - Lifting height : 6 m - Lifting speed : 2,15 m/min - Power : 1,1 kw - Voltage : 240V/50HZ/1PH	1 set
387-233	3 t x 6 m - Lifting height : 6 m - Lifting speed : 1,43 m/min - Power : 1,1 kw - Voltage : 240V/50HZ/1PH	1 set
387-234	1 t x 12 m - Lifting height : 12 m - Lifting speed : 4,30 m/min - Power : 1,1 kw - Voltage : 380V/50HZ/3PH	1 set
387-236	3 t x 12 m - Lifting height : 12 m - Lifting speed : 1,43 m/min - Power : 1,1 kw - Voltage : 240V/50HZ/1PH	1 set

Heavy duty
For industrial use

GEAR TROLLEY



ITEM NO.	SIZE	CTN
387-251	1 t x 3 m	1 pc
387-252	2 t x 3 m	1 pc
387-253	3 t x 3 m	1 pc
387-254	5 t x 3 m	1 pc

Heavy duty
For industrial use



PLAIN TROLLEY

ITEM NO.	SIZE	CTN
387-242	2 t	5 pcs
387-243	3 t	1 pc
387-244	5 t	1 pc

Heavy duty
For industrial use

HORIZONTAL LIFTING CLAMP



ITEM NO.	SIZE	CTN
387-266	0.75 t (Opening 0 - 25 mm)	1 pc
387-267	1.5 t (Opening 0 - 30 mm)	1 pc
387-268	2.0 t (Opening 0 - 40 mm)	1 pc

Heavy duty
For industrial use

VERTICAL LIFTING CLAMP



ITEM NO.	SIZE	CTN
387-273	3 t (Opening 0 - 35 mm)	1 pc
387-274	5 t (Opening 5 - 45 mm)	1 pc

Heavy duty
For industrial use

"V" TYPE SLOT PULLEY FOR SLIDING GATE

RODA PAGAR SIKU



ITEM NO.	SIZE	CTN
351-221	6 cm	60 pcs
351-222	7 cm	30 pcs
351-223	8 cm	30 pcs
351-227	10 cm	16 pcs

Zinc plated steel
Bearing with bolt

"U" TYPE SLOT PULLEY FOR SLIDING GATE

RODA PAGAR BULAT



ITEM NO.	SIZE	CTN
351-224	6 cm	60 pcs
351-225	7 cm	30 pcs
351-226	8 cm	30 pcs
351-228	10 cm	16 pcs

Zinc plated steel
Bearing with bolt

FRONT WHEEL HAND PALLET

RODA DEPAN (KECIL) HAND PALLET



ITEM NO.	SIZE	CTN
345-207	3"	40 pcs

High quality material



SCAFFOLDING CASTER W/ BRAKE

RODA SCAFFOLDING

ITEM NO.	SIZE	CTN
380-021	6"	6 pcs
380-022	8"	4 pcs

6" - max weight 200 kg

8" - max weight 250 kg

HEAVY DUTY PU CASTER SWIVEL

RODA PU HEAVY DUTY HIDUP



ITEM NO.	SIZE	CTN
380-023	4"	10 pcs
380-024	5"	10 pcs
380-025	6"	10 pcs

4" - max weight 160 kg

5" - max weight 200 kg

6" - max weight 250 kg

HEAVY DUTY PU CASTER FIXED

RODA PU HEAVY DUTY MATI



ITEM NO.	SIZE	CTN
380-026	4"	10 pcs
380-027	5"	10 pcs
380-028	6"	10 pcs

4" - max weight 160 kg

5" - max weight 200 kg

6" - max weight 250 kg

HEAVY DUTY PU CASTER W/ BRAKE

RODA PU HEAVY DUTY PAKAI REM



ITEM NO.	SIZE	CTN
380-029	4"	10 pcs
380-030	5"	10 pcs
380-031	6"	10 pcs

4" - max weight 160 kg

5" - max weight 200 kg

6" - max weight 250 kg

MEDIUM DUTY PVC CASTER SWIVEL

RODA PVC MEDIUM HIDUP



ITEM NO.	SIZE	CTN
380-032	3"	40 pcs
380-033	4"	32 pcs
380-034	5"	24 pcs

Polyurethane material

MEDIUM DUTY PVC CASTER FIXED

RODA PVC MEDIUM MATI



ITEM NO.	SIZE	CTN
380-035	3"	40 pcs
380-036	4"	32 pcs
380-037	5"	24 pcs

Polyurethane material



NUMBER PUNCH

KETOK ANGKA

ITEM NO.	SIZE	BOX	CTN
393-004	4 mm	25 sets	100 sets
393-005	5 mm	25 sets	50 sets
393-009	12 mm	10 sets	20 sets

9 pcs per set
Hardened carbon steel



LETTER PUNCH

KETOK HURUF

ITEM NO.	SIZE	BOX	CTN
393-103	3 mm	10 sets	30 sets
393-104	4 mm	10 sets	30 sets
393-108	10 mm	5 sets	10 sets

27 pcs per set
Hardened carbon steel



HYDRAULIC HOSE CRIMPER

ALAT PRESS NEPEL SELANG

ITEM NO.	SIZE	BOX	CTN
378-220	12 - 17 mm (5 T)	1 set	2 sets

Easy to use
For manual pressure

WOOD SCREW ASSORTMENTS

AKSESORIS SEKRUP KAYU



ITEM NO.	TYPE	BOX	CTN
351-105	50 pcs	12 sets	72 sets

For houseware

CABLE CLIP ASSORTMENTS

AKSESORIS KLEM KABEL PVC



ITEM NO.	TYPE	BOX	CTN
351-109	35 pcs	12 sets	72 sets

For houseware

BRASS WOOD SCREW

SEKRUP KAYU KUNINGAN



ITEM NO.	SIZE	CTN
351-126	1 1/2" x 8 mm	100 ktk

Brass material
144 pcs/box



CLEANING TONGS
ALAT JEPIT SERBAGUNA

ITEM NO.	SIZE	CTN
345-020	450 mm	80 pcs
345-021	600 mm	80 pcs

Full stainless steel material
Comfortable rubber grip



GLASS CLEANING TOOLS IRON BODY
ALAT PEMBERSIH KACA BODI BESI

ITEM NO.	SIZE	BOX	CTN
361-023	8"	25 pcs	50 pcs
361-024	10"	25 pcs	50 pcs
361-025	12"	20 pcs	40 pcs

For cleaning: glass, window & door



GLASS CLEANING TOOLS PVC BODY
ALAT PEMBERSIH KACA BODI PVC

ITEM NO.	SIZE	CTN
377-061	10" (Grey)	48 pcs
377-062	12" (Red)	48 pcs

For cleaning: glass, window & door

FLEXIBLE DRAIN CLEANER

ALAT PEBERSIH SALURAN PIPA SPIRAL



ITEM NO.	SIZE	BOX	CTN
378-107	3 m	6 pcs	24 pcs
378-108	5 m	5 pcs	10 pcs

Wire diameter 1.2 mm
Spring diameter 5.5 mm

FLEXIBLE SINK & DRY CLEANER

ALAT PEBERSIH SALURAN PIPA PLAT



ITEM NO.	SIZE	BOX	CTN	
378-109	25 FT	12 pcs	72 pcs	Rp 47.500/pc

Special for: Sink, Pool, Bathtub, etc
Plate wide 6 mm

ROTARY SPRING DRAIN CLEANER

ALAT PEBERSIH SALURAN PIPA + HANDLE



ITEM NO.	SIZE	BOX	CTN
378-110	1/4" x 10 m	1 pc	30 pcs

High quality material

SUCTION PUMP

POMPA CLOSET KARET



ITEM NO.	SIZE	CTN
376-011	HL 5018	12 pcs
376-012	HL 5017	12 pcs

High quality material
For cleaning the kitchen sink, bathroom



SCISSORS STAINLESS STEEL 2 COLOR HANDLE
GUNTING SS GAGANG KUNING HITAM

ITEM NO.	SIZE	BOX	CTN
362-024	8,5"	12 pcs	144 pcs

For office needs
Stainless steel material
2 color handle

FABRIC SCISSORS
GUNTING KAIN SS



ITEM NO.	SIZE	BOX	CTN
362-025	8,5"	12 pcs	72 pcs

Stainless steel material
Gold plate handle

SCISSORS STAINLESS STEEL YELLOW HANDLE
GUNTING SS GAGANG PVC



ITEM NO.	SIZE	BOX	CTN
362-026	7"	12 pcs	144 pcs

Stainless steel material

MULTIFUNCTION SCISSORS
GUNTING SERBAGUNA



ITEM NO.	SIZE	BOX	CTN
362-027	7,25"	12 pcs	144 pcs

Stainless steel material
Multi purpose usage

KITCHEN SCISSORS
GUNTING DAPUR

ITEM NO.	SIZE	BOX	CTN
362-028	8,5"	12 pcs	144 pcs

Stainless steel material

CLEVER CUTTER
PISAU PEMOTONG SERBAGUNA

ITEM NO.	BOX	CTN
362-055	6 pcs	30 pcs

2 in 1 knife and cutting board

Great and fast cutting: Slicing & chopping veggies, fruit, cheese, meat & more
Stainless steel material

SCISSORS
GUNTING

ITEM NO.	SIZE	BOX	CTN
362-100	6,5"	1 dzn	30 dzn

Stainless steel material

MULTI-PURPOSE SCISSORS STAINLESS STEEL
GUNTING SS

ITEM NO.	SIZE	BOX	CTN
362-102	250 mm	12 pcs	144 pcs

Stainless steel material



UTILITY KNIFE
PISAU CUTTER 3 BLADE

ITEM NO.	SIZE	BOX	CTN
362-056	18 mm	12 sets	144 sets

3 blades self loading with safety lock

FOLDING POCKET UTILITY KNIFE
PISAU LIPAT 5 BLADE



ITEM NO.	TYPE	BOX	CTN
362-060	5 blades	12 sets	48 sets

Auto lock for safety
5 blades included

UTILITY KNIFE
PISAU CUTTER 5 BLADE



ITEM NO.	SIZE	BOX	CTN
362-061	18 mm	12 sets	120 sets

Easy to use
5 blades self loading with safety lock

UTILITY KNIFE
PISAU CUTTER 2 PCS



ITEM NO.	SIZE	BOX	CTN
362-062	9 & 18 mm	12 sets	48 sets

5 extra blades included for each type

UTILITY KNIFE BLADE

REFILL PISAU CUTTER 10 PCS



ITEM NO.	SIZE	BOX	CTN
362-666	100 x 18 x 0,5 mm	10 sets	200 sets

High quality material SK4

12 IN 1 TRIP KNIFE

PISAU LIPAT 12 IN 1



ITEM NO.	BOX	CTN
362-065	12 pcs	120 pcs

Multifunction usage

STAINLESS STEEL MULTI-PURPOSE PLIERS

TANG SERBAGUNA 18 IN 1



ITEM NO.	BOX	CTN
347-070	18 pcs	72 pcs

 Multifunction usage
 Free mini pouch



MAGIC TWIST TIE

KABEL TIE

ITEM NO.	LENGTH	BOX	CTN
386-011	30 m	20 rol	200 rol
386-012	50 m	12 rol	120 rol
386-014	100 m	12 rol	120 rol

Cutter included

CABLE TIE

KABEL TIE 5 WARNA

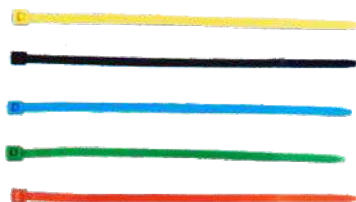

ITEM NO.	SIZE	BOX	CTN
386-031	2,5x100mm(200pcs)	10 sets	100 sets
386-032	2,5x150mm(250pcs)	20 sets	80 sets
386-033	3,5x200mm(100pcs)	20 sets	80 sets
386-034	4,5x250mm(50pcs)	20 sets	80 sets

Strap & self locking system

Colorful cable ties

CABLE TIE WHITE COLOR

KABEL TIE PUTIH

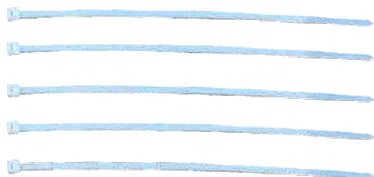

ITEM NO.	SIZE	BOX	CTN
386-035	2,5 x 100 mm	100 pack	400 pack
386-061	2,5 x 150 mm	50 pack	200 pack
386-062	3,5 x 200 mm	40 pack	160 pack
386-063	4,5 x 250 mm	40 pack	160 pack
386-064	4,5 x 300 mm	25 pack	100 pack

Strap & self locking system

Nylon

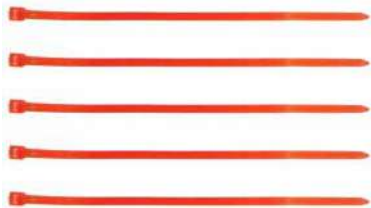

CABLE TIE RED COLOR

KABEL TIE MERAH

ITEM NO.	SIZE	BOX	CTN
386-065	2,5 x 100 mm	100 pack	400 pack
386-066	2,5 x 150 mm	50 pack	200 pack
386-067	3,5 x 200 mm	40 pack	160 pack
386-068	4,5 x 250 mm	40 pack	160 pack
386-069	4,5 x 300 mm	25 pack	100 pack

Strap & self locking system
Nylon

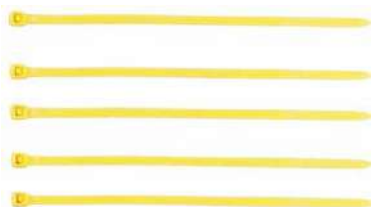

CABLE TIE YELLOW COLOR

KABEL TIE KUNING

ITEM NO.	SIZE	BOX	CTN
386-070	2,5 x 100 mm	100 pack	400 pack
386-071	2,5 x 150 mm	50 pack	200 pack
386-072	3,5 x 200 mm	40 pack	160 pack
386-073	4,5 x 250 mm	40 pack	160 pack
386-074	4,5 x 300 mm	25 pack	100 pack

Strap & self locking system
Nylon



CABLE TIE GREEN COLOR

KABEL TIE HIJAU

ITEM NO.	SIZE	BOX	CTN
386-075	2,5 x 100 mm	100 pack	400 pack
386-076	2,5 x 150 mm	50 pack	200 pack
386-077	3,5 x 200 mm	40 pack	160 pack
386-078	4,5 x 250 mm	40 pack	160 pack
386-079	4,5 x 300 mm	25 pack	100 pack

Strap & self locking system
Nylon



CABLE TIE BLACK COLOR

KABEL TIE HITAM

ITEM NO.	SIZE	BOX	CTN
386-080	2,5 x 100 mm	100 pack	400 pack
386-081	2,5 x 150 mm	50 pack	200 pack
386-082	3,5 x 200 mm	40 pack	160 pack
386-083	4,5 x 250 mm	40 pack	160 pack
386-084	4,5 x 300 mm	25 pack	100 pack

Strap & self locking system
Nylon



GLUE GUN

ITEM NO.	SIZE	BOX	CTN
360-006	Stick : 7 mm Heat : 10W	12 pcs	24 pcs
360-007	Stick : 11,2 mm Heat : 40W	12 pcs	48 pcs
360-008	Stick : 11,2 mm Heat : 60W	12 pcs	48 pcs

2 pcs glue sticks included

GLUE GUN



ITEM NO.	SIZE	CTN
360-009	Stick : 11.2 mm Heat : 80W	36 pcs

2 pcs glue sticks included
100-240V, 50-60Hz

HOT MELT GLUE STICK

GLUE STICK



ITEM NO.	SIZE	CTN
360-021	100 x 7,2 mm	144 pack

12 pcs / pack
For packaging, furniture, cloth, plastic, etc.

HOT MELT GLUE STICK

GLUE STICK



ITEM NO.	SIZE	CTN
360-022	250 x 11,2 mm	48 pack

12 pcs / pack
For packaging, furniture, cloth, plastic, etc.

MULTI TESTER AVOMETER



ITEM NO.	TYPE	BOX	CTN
397-001	YX-360-TRD	1 set	40 sets

Fuse & diode protection

MULTI TESTER AVOMETER



ITEM NO.	TYPE	BOX	CTN
397-002	SP-15-D	1 set	40 sets

Fuse & diode protection

DIGITAL MULTIMETER MULTITESTER DIGITAL



ITEM NO.	TYPE	BOX	CTN
397-003	830 B	1 set	60 sets

Easy to use with digital accuracy



SOLDERING IRON

SOLDER LISTRIK GAGANG KAYU

ITEM NO.	SIZE	BOX	CTN
360-011	100 W	25 pcs	50 pcs
360-012	150 W	25 pcs	50 pcs
360-013	200 W	25 pcs	50 pcs
360-014	300 W	25 pcs	50 pcs

Copper tips
Wooden handle



SOLDERING IRON

SOLDER LISTRIK GAGANG T

ITEM NO.	SIZE	BOX	CTN
360-016	40 W	50 pcs	100 pcs

Long life tips
3 way of soldering



SOLDERING IRON

SOLDER LISTRIK GAGANG PISTOL

ITEM NO.	SIZE	BOX	CTN
360-017	30 W	50 pcs	100 pcs

Long life tips



SOLDERING IRON

SOLDER LISTRIK GAGANG LURUS

ITEM NO.	SIZE	BOX	CTN
360-019	40 W	25 pcs	50 pcs

Long life tips

FLASH LIGHT SENER LED



ITEM NO.	SIZE	CTN
386-059	39 x 27 x 138 mm (10w)	100 pcs

Bulb Type	T6 lamp
Power Source	Dry Battery
Battery	3XAAA (include)
Zoom	X2000
Mode	High/Med/low/Srobe/SOS
Product Size	39X27X138mm

High quality aerospace aluminum

HAND SPOT LIGHT LAMPU SOROT



ITEM NO.	SIZE	CTN
392-002	LED 13 pcs	36 pcs

Bulb Type	13 LED	Function	ON/OFF
Power Source	Dry Battery	Water-Resistant	IPX5(Life Water Resistant)
Battery	4XD Batteries(not include)	Material	PP
Runtime	48 Hours	Product Size	109X199X124mm
Distance	50 M	Headlamp Size	Ø100mm

High quality material

HEAD LIGHT LAMPU SENTER KEPALA



ITEM NO.	SIZE	CTN
392-003	LED 8 pcs	60 pcs

Bulb Type	8 LED	Function	ON/OFF
Power Source	Dry Battery	Water-Resistant	Yes
Battery	3X1.5V AAA (not include)	Mode	High / Medium / Low
Lifetime Of LED	100,000 Hours		

High quality material

HEAD LIGHT LAMPU SENTER KEPALA



ITEM NO.	SIZE	CTN
392-004	5 Watt	30 pcs

Mode 2 Option	High / Low	Color Temperature	6000K
Batthey	Lithium Battery	Lamp Power	5 W
Output	350 Lumens	Voltage	3.7 V
Runtime	5 Hours	Power Source	Rechargeable Battery
Distance	100 m	Water-Resistance	IPX5(Life Water Resistant)
Material	ABS	Headlamp Size	Ø80mm

High quality material



ALUMINUM HAND PUMP

POMPA TABUNG ALUMINIUM + METER

ITEM NO.	SIZE	CTN
376-003	Ø 38 x 500 mm	10 pcs

Pressure up to 100 lbs (7kg/cm²)



HIGH QUALITY HAND PUMP

POMPA TABUNG HITAM + METER

ITEM NO.	SIZE	CTN
376-008	Ø 38 x 500 mm	10 pcs

Pressure up to 100 lbs (7kg/cm²)
High quality material



HIGH GRADE FOOT PUMP

POMPA INJAK

ITEM NO.	SIZE	BOX	CTN	
376-004	Ø 55 x 120 mm	5 pcs	10 pcs	Rp 300.000/pc

Pressure up to 100 lbs (7kg/cm²)



HOSE WITH NOZZLE FOR HAND PUMP

SELANG POMPA TABUNG KUNING

ITEM NO.	SIZE	CTN
378-102	60 cm	120 pcs

High quality material



CABLE LOCK

KUNCI SEPEDA KABEL

ITEM NO.	SIZE	CTN
346-229	8 mm x 650 mm	120 pcs

Brass cylinder



PLASTIC FUNNEL

SARINGAN MINYAK PLASTIK

ITEM NO.	SIZE	CTN
359-051	5,5"	100 pcs
359-052	6,5"	100 pcs

Flexible plastic material



HANGING SCALE

TIMBANGAN GANTUNG

ITEM NO.	SIZE	BOX	CTN
367-090	25 kg	1 pc	10 pcs
367-091	50 kg	1 pc	10 pcs
367-092	100 kg	1 pc	10 pcs

Strong body
Portable design and easy to use



MECHANICAL KITCHEN SCALE

TIMBANGAN KUE + PIRINGAN STAINLESS

ITEM NO.	SIZE	BOX	CTN
367-101	5 kg	1 set	6 sets
367-102	10 kg	1 set	6 sets
367-103	15 kg	1 set	6 sets
367-104	20 kg	1 set	6 sets

High precision scale
Full stainless steel plate

HOSE CLAMP

KLEM SELANG STAINLESS

ITEM NO.	SIZE	BOX	CTN
398-012	4"	50 pcs	500 pcs



SS 210, full stainless steel material

HOSE CLAMP WITH HANDLE

KLEM SELANG STAINLESS TUAS NYLON

ITEM NO.	SIZE	BOX	CTN
398-021	5/8"	100 pcs	2000 pcs
398-022	3/4"	100 pcs	2000 pcs
398-023	7/8"	100 pcs	2000 pcs
398-024	1"	50 pcs	2000 pcs
398-025	1 1/4"	50 pcs	1000 pcs
398-026	1 1/2"	50 pcs	1000 pcs



Stainless steel material with nylon lever

FLOATING ROPE

TALI NYLON



ITEM NO.	SIZE	CTN
385-171	6 mm x 20 m	50 rol
385-172	8 mm x 20 m	30 rol
385-173	10 mm x 20 m	20 rol

Commonly used for household purposes, car etc

PLASTIC CHAIN

RANTAI PLASTIK



ITEM NO.	SIZE	CTN
345-301	6 mm x 25 m merah	8 rol
345-302	8 mm x 25 m merah	8 rol
345-303	10 mm x 25 m merah	4 rol
345-304	12 mm x 25 m merah	4 rol
345-305	6 mm x 25 m kuning	8 rol
345-306	8 mm x 25 m kuning	8 rol
345-307	10 mm x 25 m kuning	4 rol
345-308	12 mm x 25 m kuning	4 rol
345-309	6 mm x 25 m hitam	8 rol
345-310	8 mm x 25 m hitam	8 rol
345-311	10 mm x 25 m hitam	4 rol
345-312	12 mm x 25 m hitam	4 rol

Plastic material
For barrier, parking and other purposes



WIRE KNITTED HOSE

SELANG FLEKSIBEL AIR DINGIN

ITEM NO.	SIZE	BOX	CTN
378-081	30 cm	10 pcs	200 pcs
378-082	40 cm	10 pcs	200 pcs
378-083	50 cm	10 pcs	200 pcs

Stainless steel



WIRE CORRUGATED HOSE

SELANG FLEKSIBEL AIR PANAS

ITEM NO.	SIZE	BOX	CTN
378-084	30 cm	10 pcs	200 pcs
378-085	40 cm	10 pcs	200 pcs
378-086	50 cm	10 pcs	200 pcs

Stainless steel



DRAIN HOSE

SELANG MESIN CUCI

ITEM NO.	SIZE	CTN
378-101	1" x 2 m	20 pcs

Elastic high grade PVC
For washing machine

SCOTLIGHT RAINCOAT

JAS HUJAN & CELANA SCOTLIGHT

ITEM NO.	SIZE	BOX	CTN
344-005	XL	1 set	25 sets

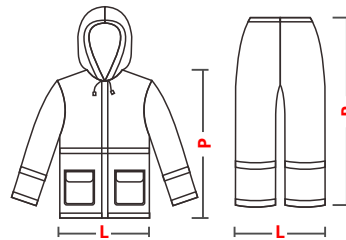

Dimensi Jas Hujan

Size	P	L
Baju	70 cm	66 cm
Celana	107cm	50 cm



Resleting kuat
Double layer



Karet pengunci
pergelangan



Scotlight
untuk safety



2 Kantong



Windproof rain coat with pants are made of 100% PVC.
Durable and portable, tear resistant and light weight. Soft material, comfortable to wear.
Breathable and Comfortable with back vents for comfort.
Equipped with scotchlite reflective

RAINCOAT

JAS HUJAN HIJAU

ITEM NO.	SIZE	BOX	CTN
344-004	M	1 pc	50 pcs



100% Vinyl

HEADGEAR FACE SHIELD

TOPENG PELINDUNG TRANSPARAN MODEL PUTAR



ITEM NO.	SIZE	BOX	CTN
383-053	6 x 7 mm	1 pc	50 pcs

Used for construction workers, protect the face from splashes of fire, small dust etc.
1 mm PP visor thickness, with aluminum
Ratchet adjustment suspension with sweatband

SAFETY GOGGLES

KACAMATA SAFETY TRANSPARAN



ITEM NO.	SIZE	CTN
383-074	GB 010	200 pcs

CE Standard

SAFETY GOGGLES

KACAMATA SAFETY ANTI KABUT



ITEM NO.	CTN
383-081	200 pcs

High quality
CE Standard

SAFETY GOGGLES
KACAMATA SAFETY



ITEM NO.	SIZE	BOX	CTN
383-076	GB 028	20 pcs	40 pcs

CE Standard

SAFETY GOGGLES
KACAMATA SAFETY



ITEM NO.	SIZE	BOX	CTN
383-077	GB 048	20 pcs	40 pcs

CE Standard

SAFETY GOGGLES
KACAMATA SAFETY



ITEM NO.	TYPE	BOX	CTN
383-078	GB 014-1	25 pcs	100 pcs

CE Standard



FILTER DUST
MASKER KUNING PVC

ITEM NO.	BOX	CTN
383-003	2 dzn	12 dzn

Adjustable elastic band in PVC construction
Replaceable non toxic pollen powder and paint spray



EAR PLUG
TUTUP TELINGA SILIKON

ITEM NO.	BOX	CTN
383-062	200 pcs	400 pcs

Silicone material
CE standard



EAR MUFF
TUTUP TELINGA GAGANG PLASTIK

ITEM NO.	BOX	CTN
383-063	10 pcs	60 pcs

Soundproof
CE standard

PVC GLOVES

SARUNG TANGAN PVC



ITEM NO.	SIZE	COLOR	CTN
384-004	14"	Coffee	6 dzn

Oil resistant
High quality material

PVC GLOVES

SARUNG TANGAN PVC



ITEM NO.	SIZE	COLOR	CTN
384-005	14"	Blue	6 dzn

Oil resistant
High quality material

PE WARNING TAPE

POLICELINE



ITEM NO.	SIZE	CTN
394-026	2" x 300m (Hitam Kuning)	36 rol
394-027	3" x 300m (Hitam Kuning)	24 rol
394-028	2" x 300m (Putih Merah)	36 rol
394-029	3" x 300m (Putih Merah)	24 rol

Application: Suitable for traffic, police, security, construction site, and other general purpose warning use



SAFETY BELT
SABUK PENGAMAN

ITEM NO.	BOX	CTN
385-101	1 pc	25 pcs

For industrial
Standard: S. S. 402: part 1: 1997
Maximum safe drop 1,8 meter



SAFETY BELT
SABUK PENGAMAN FULL BODY

ITEM NO.	BOX	CTN
385-102	1 pc	10 pcs

Made in Taiwan
For industrial
Standard: S. S. 402: part 1: 1997
Maximum safe drop 1,8 meter



FULL BODY SAFETY HARNESS
SABUK PENGAMAN FULL BODY HOOK BESAR

ITEM NO.	BOX	CTN
385-103	1 pc	10 pcs

For industrial
100% polyamide, CE. 0321 EN 361:2002 EN 362



SAFETY LANYARD
TALI PP SABUK PENGAMAN

ITEM NO.	SIZE	BOX	CTN
385-104	1,5 M	1 pc	20 pcs

For industrial



LIGHT FOR LIFEBOUY
LAMPU PELAMPUNG AIR

ITEM NO.	BOX	CTN
344-022	1 pc	20 pcs

White LED light
High quality material



LIFEBOUY
PELAMPUNG AIR

ITEM NO.	SIZE	CTN
378-192	2,5 kg	5 pcs

Fiber material with pp rope



DIVING MASK
KACAMATA SELAM

ITEM NO.	BOX	CTN
383-041	1 pc	50 pcs

Made in Taiwan
Tempered glass



SCUBA DIVING REGULATOR
REGULATOR SELAM

ITEM NO.	BOX	CTN
383-044	1 pc	50 pcs

Made in Taiwan
Warning: Do not exceed 350 psi pressure, may cause damage or personal injury

WELDING GLOVES

SARUNG TANGAN LAS KULIT



ITEM NO.	SIZE	COLOR	CTN
384-001	14"	Red	5 dzn Rp 1.200.000/dzn

High quality genuine leather

WELDING GLOVES

SARUNG TANGAN LAS KULIT



ITEM NO.	SIZE	COLOR	CTN
384-002	14"	Blue	5 dzn
384-008	18"	Blue	5 dzn

High quality genuine leather

WELDING GLOVES

SARUNG TANGAN LAS KULIT



ITEM NO.	SIZE	COLOR	CTN
384-003	16"	Yellow	5 dzn

High quality genuine leather

WELDING GLOVES

SARUNG TANGAN LAS KULIT



ITEM NO.	SIZE	COLOR	CTN
384-001	14"	Red	5 dzn Rp 1.260.000/dzn

High quality genuine leather

WELDING GLOVES

SARUNG TANGAN LAS KULIT



ITEM NO.	SIZE	COLOR	CTN
384-002	14"	Blue	5 dzn
384-008	18"	Blue	5 dzn

High quality genuine leather

WELDING GLOVES

SARUNG TANGAN LAS KULIT



ITEM NO.	SIZE	COLOR	CTN
384-003	16"	Yellow	5 dzn

High quality genuine leather

WATER LEVEL CONTROL SWITCH

PELAMPUNG AIR TANDON



ITEM NO.	BOX	CTN
378-191	1 set	48 sets

Strong PVC body

BALL VALVE

BALL VALVE PVC POLOS GAGANG SS



ITEM NO.	SIZE	BOX	CTN
378-207	1 1/4"	6 pcs	60 pcs

Heavy duty
Handle stainless with rubber

NEW



MANIFOLD GAUGE SET REGULATOR FREON AC

ITEM NO.	TYPE	BOX	CTN
375-010	R23/R410	1 set	10 sets

Specifications:

- Refrigerants: R22, R32, R134A, R410A
- Body material: aluminum alloy
- Hose length: 1.5m
- Hose working pressure: 800psi
- Hose burst pressure: 4000psi

NEW



SPRAY GUN STICK SPRAYER KUNINGAN

ITEM NO.	SIZE	BOX	CTN
378-053	25 cm	1 pc	50 pcs
378-054	35 cm	1 pc	50 pcs
378-055	45 cm	1 pc	50 pcs

Brass material sprayer head

NEW



5PCS SCREWDRIVER BITS SET MATA OBENG MAGNET BOLAK BALIK 5PCS

ITEM NO.	SIZE	BOX	CTN
348-184	Ph2 x 65 mm	20 sets	200 sets

Color: brown, S2 material

NEW



HAND JUICER ALAT PRESS JERUK

ITEM NO.	SIZE	BOX	CTN
362-018	39.5 x 21 x 17 cm	1 set	2 sets

Used for: fruit extracts, orange, lime, lemon, pomegranate etc.

HOSE CLAMP
KLEM SELANG HEAVY DUTY



ITEM NO.	SIZE	BAUT	HOSE	BOX	CTN
398-041	17-19mm	M5	3/8"	100 pcs	600 pcs
398-042	20-22mm	M5	1/2"	100 pcs	600 pcs
398-043	23-25mm	M5	5/8"	80 pcs	480 pcs
398-044	26-28mm	M5	5/8-3/4"	80 pcs	480 pcs
398-045	29-31mm	M6	3/4"	40 pcs	400 pcs
398-046	32-35mm	M6	1"	50 pcs	300 pcs
398-047	36-39mm	M6	1 1/8"	40 pcs	240 pcs
398-048	40-43mm	M6	1 1/4"	40 pcs	240 pcs
398-049	44-47mm	M6	1 3/8"	25 pcs	250 pcs
398-050	48-51mm	M6	1 1/2"	20 pcs	200 pcs
398-051	52-55mm	M6	1 1/2"-1 5/8"	20 pcs	200 pcs
398-052	56-59mm	M6	1 3/4"-1 7/8"	20 pcs	200 pcs
398-053	60-63mm	M6	2"	15 pcs	150 pcs
398-054	64-67mm	M8	2 1/8"	15 pcs	150 pcs
398-055	68-73mm	M8	2 1/4"	10 pcs	120 pcs
398-056	74-79 mm	M8	2 1/2"	10 pcs	120 pcs
398-057	80-85mm	M8	2 3/4"	10 pcs	120 pcs
398-058	86-91mm	M8	2 7/8"-3"	10 pcs	90 pcs
398-059	92-97mm	M8	3 1/4"	10 pcs	90 pcs
398-060	98-103mm	M8	3 1/2"	10 pcs	90 pcs
398-061	104-112mm	M8	3 3/4"	10 pcs	100 pcs
398-062	113-121mm	M8	4"	10 pcs	100 pcs
398-063	122-130mm	M8	4 1/4"	10 pcs	100 pcs
398-064	131-139mm	M10	4 1/2"	10 pcs	100 pcs
398-065	140-148mm	M10	5"	10 pcs	100 pcs
398-066	149-161mm	M10	5 1/4"-5 1/2"	10 pcs	70 pcs
398-067	162-174mm	M10	6"	10 pcs	50 pcs
398-068	175-187mm	M10	6 1/4"-5 1/2"	10 pcs	50 pcs
398-069	188-200mm	M10	7"	10 pcs	50 pcs
398-070	201-213mm	M10	7 1/4"-7 1/2"	10 pcs	50 pcs
398-071	214-226mm	M10	8"	10 pcs	50 pcs

Carbon steel material
Heavy duty pipe clamp are made color full zinc plated for anti-rust



INDUSTRIAL RUBBER SHEET W/LAYER CLOTH
PACKING KARET LAPIS 1 BENANG

ITEM NO.	TYPE	BOX	CTN
379-002	2 mm x 1 M x 20 M (68 kg)		1 rol
379-003	3 mm x 1 M x 20 M (102 kg)		1 rol
379-004	4 mm x 1 M x 20 M (136 kg)		1 rol
379-005	5 mm x 1 M x 10 M (85 kg)		1 rol
379-006	6 mm x 1 M x 10 M (102 kg)		1 rol
379-007	8 mm x 1 M x 10 M (136 kg)		1 rol
379-008	10 mm x 1 M x 10 M (170 kg)		1 rol



LIFE JACKET
BAJU PELAMPUNG

ITEM NO.	SIZE	CTN
378-193	55 x 60 x 7 cm	6 pcs



TOOL BOX METAL CASE
TOOL BOX 1 SUSUN TIPE JAPAN

ITEM NO.	TYPE	CTN
391-014	370x160x120 mm (YT-350)	12 pcs
391-015	430 x 170 x 130 mm (YT-410)	12 pcs



UTILITY KNIFE FOR ACRYLIC PLATE
PISAU CUTTER AKRILIK TIPE SK 5

ITEM NO.	SIZE	BOX	CTN
362-144	140 mm	12 pcs	120 pcs

Sk5 blade material
 Used for: cutting acrylic and various types of plastic pmma, pvc, pc, abs



REFLECTIVE ADHESIVE TAPE
STICKER REFLEKTOR

ITEM NO.	SIZE	COLOR	CTN
360-122	50 mm x 45 m	Kuning	24 rol
360-123	50 mm x 45 m	Merah	24 rol
360-124	50 mm x 45 m	Putih	24 rol

Yellow & white color: for left-right side of the car
Red color: for rear car



GLASS TILE OPENER
MATA POTONG KERAMIK 11 PCS

ITEM NO.	SIZE	CTN
365-103	2-10 mm	40 sets

- 1 Glass tile knife
- 1 Glass tile delimiter
- 2 Glass cutter head
- 3 Open barrel reserve foot pad
- 1 Scrolls
- 2 Glass knife special oil
- 1 Hex key

Cutting length 3000 meters
Used for: cutting ceramic, granite, glass & mirror



STEEL TAPE W/ CHROME PLATED SHELL
METERAN PLAT BESI

ITEM NO.	SIZE	CTN
368-031	30 m	24 pcs
368-032	50 m	24 pcs

High quality steel plate tape



TCT CIRCULAR SAW FOR BUSH CUTTER
PISAU POTONG RUMPUT BULAT TCT

ITEM NO.	SIZE	BOX	CTN
362-143	255 x 25.4 x 40T	10 pcs	50 pcs

Grass cutting knife for any kind of machine
Used for: cutting grass, bushes, plants, twigs, branches



COUPLING HEX WRENCH
KUNCI RING MUR KOPLING

ITEM NO.	SIZE	BOX	CTN
346-795	39 x 41 mm	12 pcs	48 pcs

Used for: installing/removing automatic motorcycle cvt clutch



UNIVERSAL HOLDER FOR FLYWHEEL
KUNCI FLY WHEEL UNIVERSAL

ITEM NO.	SIZE	BOX	CTN
346-796	12" x 12 - 110 mm	6 pcs	48 pcs

Used for: clutch holder on automatic motorcycle cvt



5PCS SPARE BLADE
REFILL PISAU CUTTER AKRILIC

ITEM NO.	BOX	CTN
362-145	50 sets	400 sets

5 pcs blades, Sk5 material
Used for: cutting acrylic and various types of plastic pmma, pvc, pc, abs



DIAMOND METAL CUTTING DISC
DIAMOND WHEEL METAL MULTIFUNGSI

ITEM NO.	SIZE	BOX	CTN
366-017	100 x 20 x 1.6 mm	10 pcs	100 pcs

RPM 14500, Max 80 m/s
Used for: cutting metal, plastic, wood, ceramic, aluminum materials

NEW

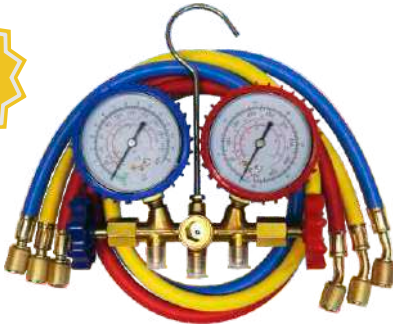

MANIFOLD GAUGE SET REGULATOR FREON AC

ITEM NO.	TYPE	BOX	CTN
375-009	R12/R22	1 set	10 sets

Specifications

- Refrigerants: R12, R22
- Gauge diameter: 7cm/2.8inch
- Charging hose length: 90cm/36inch
- Hose working pressure: 500psi
Hose burst pressure: up to 4000psi

NEW



LATEX GLOVES SARUNG TANGAN KARET ORANGE

ITEM NO.	SIZE	CTN
384-020	L	240 psg

High quality latex material

Used for: gardening, industry, fish processing, mining, automotive, household, etc

Automotive Safety Equipment
Air Tools Hand Tools
Building Equipment
Garden Tools Hardware
Houseware
Cutting Tools

DIRECTORY
2023

